



vLoc-5000 User Handbook
(English Edition)
Version 1.2



Table of Content

General Safety & Care Information	1
1.1 Who Can Use This Equipment	1
1.2 Work-site Safety	1
1.3 Equipment Safety	1
1.4 Batteries and Environmental Safety	1
1.4.1 Alkaline Batteries (Non Rechargeable)	1
1.4.2 Nickel Metal Hydride Batteries (Rechargeable)	1
1.4.3 Lithium-Ion Batteries (Rechargeable)	2
1.4.4 Lithium Metal Batteries (Non Rechargeable)	2
1.4.5 General Rules Regarding Disposal of Batteries	2
1.4.6 Transportation of Lithium-ion and Lithium Metal Batteries	3
1.5 Care of Equipment	3
1.6 Care When Interpreting the Information Provided by the Locator	3
1.7 American & Canadian Safety Notices	4
Service & Support	5
2.1 Serial Number and Software Revision Number	5
2.2 Distributors and Service Centers Closest to You	6
vLoc-5000 Receiver	7
3.1 vLoc-5000 Receiver	7
3.2 Charging the Receiver Batteries	8
3.3 vLoc-5000 Receiver Main Display and Pushbutton	9
3.4 vLoc-5000 Receiver Screen Shots	10
3.5 Distance Sensitive Left/Right Guidance™ Display	11
3.6 Locating Mode (Response)	12
3.6.1 Peak Response Mode	12
3.6.2 Broad Peak Mode	12
3.6.3 Null Mode	13
3.6.4 Sonde Mode	13
3.7 Audio	14
3.8 Sensitivity Control	14
3.9 Frequency Selection	15
3.10 Information Pushbutton (Depth & Current)	15
3.11 Information Pushbutton (Setup Menu)	16
Data Logging	17
4.1 Bluetooth	17
4.1.1 Fitting the Bluetooth Module	17
4.2 Holux GPS Device Overview	18
4.2.1 Pairing with the vLoc-5000 Receiver	19
4.2.2 Gathering Data in Active Modes	19

4.2.3	Gathering Data in Power and Radio (Passive) Modes	19
4.2.4	Transferring Data from the Locator to a Computer	20
4.3	Trimble ProXT/XH	20
4.3.1	Trimble ProXT/XH Setting up Procedure	20
4.3.2	Transferring Data from the vLoc-5000 to a Computer	22
4.4	MyLocator2	22
4.4.1	Launch the Application	22
4.4.2	Splash Screen	24
4.4.3	Upload Data Files	25
4.4.4	Software Update	26
4.4.5	Advanced Configuration Tool	27
4.4.6	Switch On/Off User Menu Settings	27
4.4.7	Switching On/Off Frequency Selections	28
4.4.8	Saving a Configuration	29
4.4.9	Configuration Lock Dongle	29
4.4.10	Icon Summary	32
Loc-10TxSIS Transmitter		33
5.1	Loc-10TxSIS Transmitter Overview	33
5.2	Transmitter Battery	34
5.2.1	Removing the Battery Tray	34
5.2.2	Replacing the Alkaline Battery	34
5.2.3	Rechargeable Batteries	35
5.2.4	Re-fitting the Battery Tray	35
5.2.5	Battery Charging and Disposal	35
5.2.6	Battery Condition Indication	36
5.3	Transmitting Modes	36
5.3.1	Induction Mode (Only on selected frequencies and not SIS frequencies)	36
5.3.2	Direct Connection Mode	37
5.3.3	Clamp Mode	37
5.3.4	Connection Block	38
5.3.5	Frequencies and Power Output	39
5.3.6	Most Used Frequencies (Frequency Selection) Feature	40
5.3.7	"Dual frequency" Mode	41
5.4	Information	42
Using the vLoc-5000		43
6.1	Using the Receiver	43
6.1.1	Line Locating	43
6.1.2	Depth & Current Measurement	43
6.1.3	Sonde Location	44
6.1.4	Using the Compass Feature to Locate Sondes	45
6.2	Passive or Active Location	46
6.2.1	Passive Locating	46

6.2.2	Active Locating	47
6.3	Applying the Transmitter's Signal	47
6.3.1	Direct Connection	47
6.3.2	Clamp (Coupler)	48
6.3.3	Induction	49
6.3.4	Searching (Sweeping) an Area	50
6.3.5	Tracing a Buried Line	50
6.3.6	Pinpointing & Confirming the Buried Line	51
6.3.7	Distorted Fields	51
6.3.8	Measuring Depth and Current	52
6.3.9	Cable Tracing using Signal Select or Signal Direction Signals	53
6.3.10	Signal Direction Precision Identification	56
6.4	Using the Accessories	58
6.4.1	Using the LPC Separation Filter	58
6.4.2	Using the A-frame in Fault Finding	58
6.4.3	Using the Remote Antenna USB	61
6.4.4	Signal Select™ Clamp	61
Accessories & Options		64
7.1	A-frame (Optional)	64
7.2	Remote Antenna (Optional)	64
7.3	Loc-10Tx Vehicle Power Lead (Optional)	64
7.4	Loc-10Tx Outdoor Power Supply (Optional)	64
7.5	LPC Separation Filter (Optional)	65
7.6	Receiver Vehicle Charging Lead(Optional)	65
7.7	Sonde (Optional)	65
7.8	Clamp (Optional)	66
7.9	Lithium-ion Rechargeable Battery Pack (Standard)	66
7.10	Receiver Battery Charger (Standard)	66
7.11	USB Cable (Standard)	66
7.12	Alkaline Battery Holder (Standard)	66
7.13	Ground Stake(Standard)	67
7.14	Direct Connection Lead (Standard)	67
7.15	Ground Spool (Optional)	67
7.16	Banana Plugs Adapter (Optional)	67
7.17	Loc-5Tx/10Tx Charger	67
7.18	Loc-10Tx Rechargeable Battery Tray	67
7.19	Loc-10Tx Alkaline Battery Tray	67
Glossary		68

General Safety & Care Information

1.1 Who Can Use This Equipment

- This equipment must only be used by people suitably trained in the use of pipe and cable locators.

1.2 Work-site Safety

- Use your companies, or other applicable safety code and rules when using this equipment.
- Unless having the required authorization, license and appropriate training – do NOT make connections to any pipe, cable or conductor.
- The equipment should not come in contact with corrosive or hazardous chemicals, or gases, dust.
- Do NOT directly connect this equipment to cables or pipes that have a potential difference to ground of greater than 35V AC.

1.3 Equipment Safety

- Do NOT open the enclosures (housings) of either the transmitter or receiver.
- Place the ground stake firmly in the ground before connecting the cable from the transmitter.
- Do NOT hold any uninsulated portion of the connection leads & clips when the transmitter is switched on.

1.4 Batteries and Environmental Safety

Vivax-Metrotech products use four types of batteries:

- Alkaline batteries – non rechargeable
- Ni-MH (Nickel Metal Hydride) batteries – rechargeable
- Lithium-ion batteries – rechargeable
- Lithium metal batteries – (small non rechargeable button cells for “clock” applications)

1.4.1 Alkaline Batteries(Non Rechargeable)

- When replacing the alkaline batteries – use only the size and type specified – do NOT mix battery types (rechargeable and alkaline).
- Do NOT mix partially discharged and fully charged cells in the same battery pack – do NOT mix old with new.
- Never attempt to charge alkaline batteries.

1.4.2 Nickel Metal Hydride Batteries (Rechargeable)

- When using rechargeable batteries, **use only the correct charging device** supplied or specified by the manufacturer. The battery pack or the battery charger will contain circuitry to manage the charging process – other chargers (even if they have the same connector,

1 General Safety & Care Information

polarity, voltage & current rating will not have the same control circuitry and can cause damage to the product, overheating, and in extreme cases fire or harm to the individual.

- Do NOT assume that if the plug fits it is the correct charger – a charger with the correct part number MUST be used – just because it is a Vivax-Metrotech charger and the plug fits does NOT mean it is the correct charger.
- Before using for the first time, charge rechargeable batteries for 6 hours. If at any time the rechargeable batteries do NOT last as long as anticipated – discharge fully and then charge for 6 hours.
- Care should be taken when charging batteries – NEVER repeatedly recharge batteries (or turn power off & on) without using the instrument. If used with an inverter in a vehicle – charge the product then unplug the charger and do NOT charge again until the rechargeable batteries have been used for at least ten minutes. Failure to do this could result in the overcharging of the battery which will shorten the life of the battery, and could in some circumstances cause overheating or fire.
- If ever the product becomes hot during the charging process IMMEDIATELY unplug the charger and use the rechargeable batteries for at least 10 minutes before recharging. If this reoccurs the next time the unit is charged – return immediately to Vivax-Metrotech for repair.
- Do NOT charge batteries for prolonged periods of time without using the locator for at least 10 mins. Charging for prolonged period of time could overcharge the battery, reduce the battery life and in extreme circumstances cause damage to the locator and fire.

1.4.3 Lithium-Ion Batteries (Rechargeable)

- Lithium-ion Batteries – some products use Lithium-ion batteries – the requirements for marking and transportation are still developing. Please contact Vivax-Metrotech before shipping products containing Lithium-ion batteries or Lithium-ion battery packs on their own for any “special instructions”.

1.4.4 Lithium Metal Batteries (Non Rechargeable)

- Commonly known as “button cells” these are small – non rechargeable batteries used to power internal “clocks” within some units (similar to computers). Generally they have a life of 3-5 years.
- Under no circumstances should any attempt be made to charge these batteries.
- Dispose of to your company’s work practice/environmental standards, the prevailing laws, or recognized best practice. Always dispose of batteries responsibly.

1.4.5 General Rules Regarding Disposal of Batteries

- NEVER disassemble a battery, or battery pack.
- Never dispose of in a fire or water.
- Dispose of batteries in accordance with your Company’s work practice/environmental standards, the prevailing laws, or recognized best practice. Always dispose of batteries responsibly.

1.4.6 **Transportation of Lithium-ion and Lithium Metal Batteries**

- The Lithium-ion and Lithium metal batteries used in Vivax-Metrotech products meet the required safety standards and include the designated protection circuitry.
- Recent regulation changes require that when batteries with Lithium-ion and Lithium metal batteries are transported the packaging **MUST** include specified warning labels. **Please contact Vivax-Metrotech Customer Service (USA 1-800-446-3392, International +1-408-734-1400 (USA Pacific Time Zone)) for more details.**
- Regulations have also changed regarding the shipping of spare battery packs (battery packs that are not inside a product). There are limitations on the weight of the package, and the packaging must be marked with the appropriate warning labels. **Please contact Vivax-Metrotech Customer Service (USA 1-800-446-3392, International +1-408-734-1400 (USA Pacific Time Zone)) for more details.**
- Vivax-Metrotech vLoc Series 2 products using Lithium-ion battery are classified as "not restricted" they can be shipped normally by road/rail/sea & air (passenger & freight aircraft) without restrictions.



IMPORTANT

Remember – Batteries contain dangerous chemicals – They can be affected by many things such as water ingress or heat – In some circumstances they can explode. They also can cause electric shocks!

1.5 **Care of Equipment**

- Use equipment only as directed in this User Handbook.
- Do NOT immerse any part of this equipment in water.
- Store in a dry place.
- Keep equipment in the case provided when not in use.
- If left for prolonged period of time – remove alkaline batteries.
- Keep unit clean and free of dust and dirt.
- Protect against excessive heat.

1.6 **Care When Interpreting the Information Provided by the Locator**

- Like all locators – this instrument is locating, and providing depth and current readings based on electromagnetic signals that radiate from the buried cable or pipe. In most cases these signals will enable the locator to pinpoint both position depth and current correctly.
- BEWARE – in some cases other factors will distort electromagnetic fields radiating from cable or pipe being located, resulting in incorrect information.
- Always locate responsibly, and use information learned during your training to interpret the information provided by the locator.
- Do NOT provide information regarding depth of cable or pipe to anyone unless authorized to do so by your company.
- REMEMBER that depth measurements are to the center of the electromagnetic field or pipe – In the case of pipes this may be significantly deeper than the top of the pipe.

1.7 American & Canadian Safety Notices

USA

- This transmitter and receiver comply with the general conditions of operation, pursuant to part 15 of the FCC Rules.
 - CFR 47 Part 2
 - CFR 47 Part 15
- Changes or modifications not expressly approved by the manufacturer could void the user's authority to operate the products.

CANADA

- Equipment is for use by trained operators only, and not for general household or consumer use.
- Operation is subject to the following two conditions: (1) this device may not cause interference, and (2) this device must accept any interference that may cause undesired operation of the device.

EUROPE

- Vivax-Metrotech confirms that the location system is compliant with relevant provision of European directive 1999/5/EC.
- EN 55011
 - EN 61000-4-2: A1 & A2
 - EN 61000-4-3
 - EN 61000-4-8: A1
 - ETSI EN 300 330-2
 - ETSI EN 301 489-1
 - ETSI EN 301 489-3

Service & Support

2.1 Serial Number and Software Revision Number

Always quote your receiver and transmitter model number, serial number and software revision number when requesting product support. They can be found as follows: (for reference only)



1	Model & Serial Number
---	-----------------------

NOTE

The transmitter Model & Serial Number can be found at the bottom of the transmitter and also inside the transmitter between the battery tray and the main module of transmitter.



Software Revision Number: On both receiver and transmitter the software revision number is displayed on the LCD during the startup sequence or can be found in the “About” section of the user menu.

2.2 Distributors and Service Centers Closest to You:

United State of America	United Kingdom
<p>Vivax-Metrotech Corporation 3251 Olcott Street, Santa Clara, CA 95054, USA Website : www.vivax-metrotech.com</p> <p>Sales & Sales Support: T/Free : 800-446-3392 Tel : +1-408-734-1400 Fax : +1-408-734-1415 Email : sales@vxmt.com</p> <p>Application Support: T/Free : 800-624-6210 Tel : +1-408-454-7159 Fax : +1-408-743-5597 Email : applications@vxmt.com</p> <p>Service & Repairs: T/Free : 800-638-7682 Tel : +1-408-962-9990 Fax : +1-408-734-1799 Email : service@vxmt.com</p> <p>All Other Department: T/Free : 877-330-1647 Tel : +1-408-734-3880 Fax : +1-408-962-9993</p>	<p>Vivax-Metrotech Ltd. 14-15, Bishops Court Gardens, Bishops Court Lane, Clyst St. Mary, Exeter, Devon, EX5 1DH, UK</p> <p>Tel : +44(0)1392-368833 Website : www.vivax-metrotech.com Email : salesUK@vxmt.com</p>
	Canada
	<p>Vivax Canada Inc. 41 Courtland Ave Unit 6, Vaughan, ON L4K 3T3, Canada</p> <p>Tel : +1-289-846-3010 Fax : +1-905-752-0214 Website : www.vivax-metrotech.com Email : CanadianSales@vxmt.com</p>
	Europe
	<p>SebaKMT Seba Dynatronic Mess-und Ortungstechnik GmbH Dr.-Herbert-lann-Str. 6, 96148 Baunach, Germany</p> <p>Tel : +49-9544-680 Fax : +49-9544-2273 Website : www.sebakmt.com Email : service@sebakmt.com</p>
Australasia	China
<p>Vivax-Metrotech AUS Unit 1, 176 South Creek Road, Cromer NSW 2099, Australia Tel : +61-2-9972-9244 Fax : +61-2-9972-9433 Website : www.vivax-metrotech.com.au Email : sales@vxmtaus.com service@vxmtaus.com</p>	<p>Leidi Utility Supply (Shanghai) Ltd. No.780, Tianshan Rd, Shanghai, China 200051</p> <p>T/Free : 4008-206-719 Tel : +86-21-5235-3001 Fax : +86-21-5235-8365 Website : www.leidi.cn Email : info@leidi.cn</p>

vLoc-5000 Receiver

3.1 vLoc-5000 Receiver

The vLoc-5000 is a Precision Location System designed to meet the needs of Utility Companies and their contractors. The following describes the features and use of the receiver:



1	Optional Bluetooth Module	6	Charging Socket
2	Pushbutton & Display	7	Mini USB Port Data Transfer and Software Upgrade
3	Carbon Fiber Reinforced Antenna Assembly	8	Accessories Port
4	Accessory & Charging Sockets	9	Model# & Serial#
5	USB Memory Stick Data Transfer, active on some models	10	AA Battery Pack/Rechargeable Battery Pack

3.2 Charging the Receiver Batteries

The vLoc-5000 can be used with either alkaline batteries or it can be supplied with an interchangeable rechargeable battery pack.



When alkaline battery is used, Icon A will appear on the screen. When the rechargeable battery pack is used, Icon B will be displayed.

In both cases, the number of bars illuminated within the battery icon indicates the amount of charge remaining.

Rechargeable batteries are supplied with a mains charger. This is specific to the batteries, avoid the use of other manufacturers' chargers as these may damage the battery pack and may result in overheating of the battery pack.

To charge the rechargeable batteries, first make sure the pack is inserted in the receiver battery compartment as charging is done inside the receiver.

Connect the charger to the charging socket of the receiver. Connect charger to the mains and switch on. The LED indicator on the charger will illuminate red until the batteries are fully charged at which time the LED will change to green.



WARNING

Rechargeable batteries are supplied with a mains or 12V DC charger. These are specific to the batteries. Only use the charger that is appropriate for the batteries in the product. If in doubt, call Vivax-Metrotech Customer Service. Failure to use the appropriate charger could result in damage to the battery pack, locator and in extreme cases cause fire.

Avoid charging the unit in extreme temperature conditions. (i.e. below 0°C and above 45°C)

Although Vivax-Metrotech batteries include all the required safety related features always immediately discontinue use of the charger and battery pack if the battery pack becomes excessively warm. Return both to where they were purchased for investigation.

Always ensure batteries have at least a partial charge if storing for long periods without use.

Dispose of all batteries in accordance with your company procedures and Federal/State and local regulations.

Never dismantle batteries, put them in fire, or get wet.

3.3 vLoc-5000 Receiver Main Display and Pushbutton

The vLoc-5000 has several display options – the display shown below is representative of the types of display and icons used.

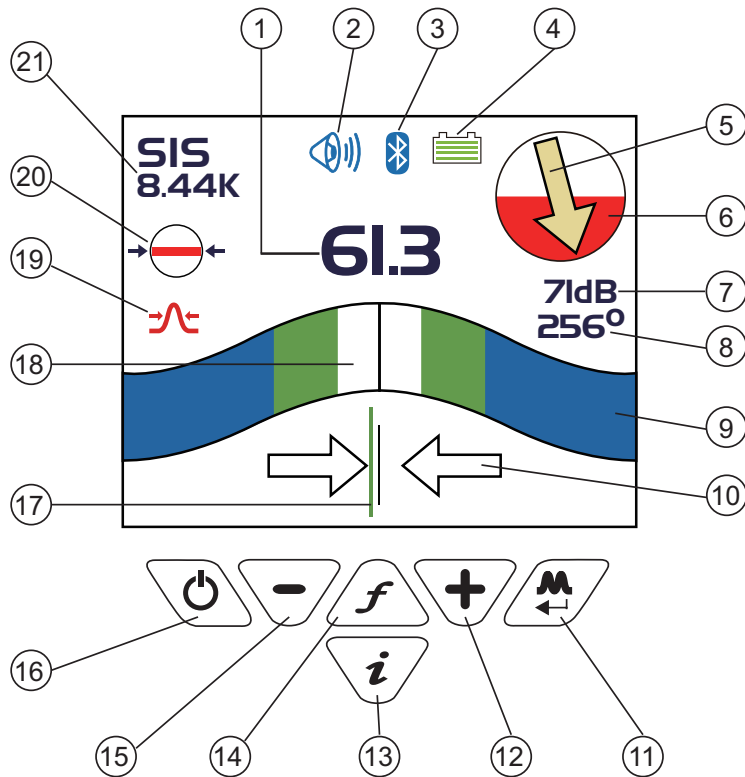

1	Digital Display of Signal Response	12	Gain Control (increase gain)
2	Loudspeaker Status	13	Information Depth/Current Measurement
3	Bluetooth and GPS Signal Quality	14	Frequency Select
4	Alkaline/Rechargeable Battery Status	15	Gain Control (reduce gain)
5	Compass Line Direction Indicator	16	On/Off Control
6	Distortion Indicator	17	Cable Position Indicator
7	db Gain Setting	18	Peak Signal Indication
8	Distortion Phase Angle	19	Location Mode (Peak, Null, Sonde, Broad, Peak Arrows)
9	Analogue Display of Signal Response	20	Signal Select Direction
10	Left vs Right Indication	21	Frequency
11	Location Mode Select		

Note: Bluetooth function is available in vLoc-5000 receiver with Bluetooth module only.

3.4 vLoc-5000 Receiver Screen Shots

vLoc-5000 Receiver Menus(Actual menu may differ)

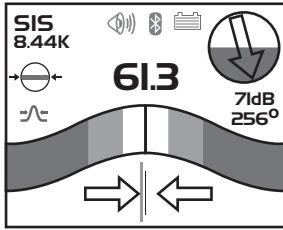

Main Display

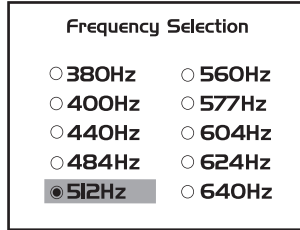

Setup Menu – Frequencies
Frequencies selected here are the only ones displayed in the frequency box on the Main Display

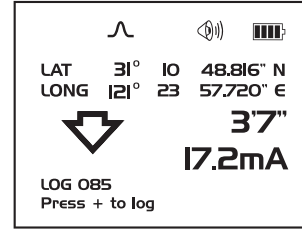

Depth & Current Measurement

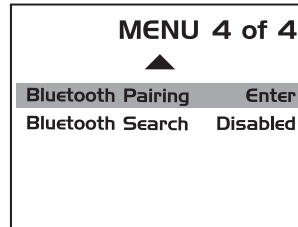
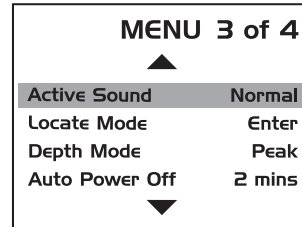
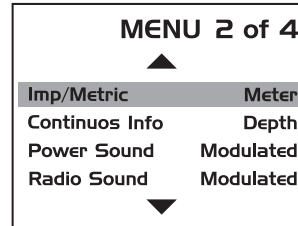
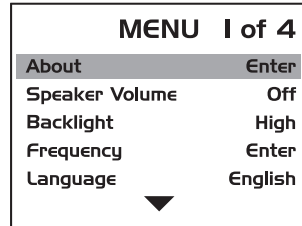

Main Menu

The vLoc-5000 is a Precision Location System designed to meet the needs of Utility Companies and their contractors. The following describes the features and use of the receiver.

3.5 Distance Sensitive Left/Right Guidance™ Display

The Left/Right display is tremendously useful in refining the precise location of the target line. The vertical green bar represents the underground utility and when shown on the left of centerline it indicates the target is also to the left.

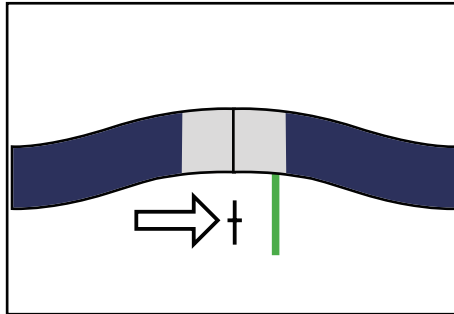

Distance Sensitive Left/Right Guidance

Using Vivax-Metrotech's Distance Sensitive Left/Right Guidance feature, the deflection distance of the vertical black bar away from the center of the display is proportional to the distance off center from the underground line. Although this is strictly true only when the field is free of distortion, the Left/Right display still plays an important role in sorting out what is going on in the underground utility environment.

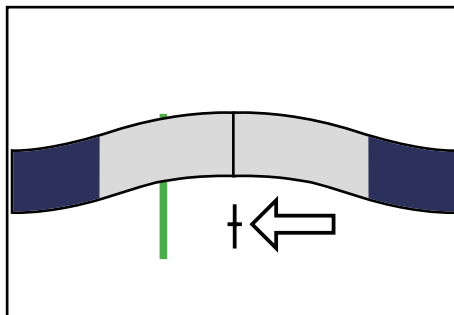

Distance Sensitive Left/Right Guidance

Often the receiver is used in a left to right sweeping motion over the centerline of the tracked utility. When the action in the Left/Right display is non-symmetric, this can be a warning of the presence of distortion in the field. Care should be taken to determine the effect of other cables in the locate zone that might be creating distortion by carrying bleedover and return currents.

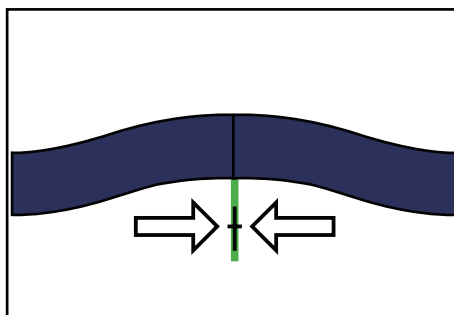

Distance Sensitive Left/Right Guidance

3.6 Locating Mode (Response)

The vLoc-5000 receiver has four antennas, and these can be toggled through different configurations (modes) to provide different responses to the signals radiating from the buried pipes and cables. The modes are:

3.6.1 Peak Response Mode

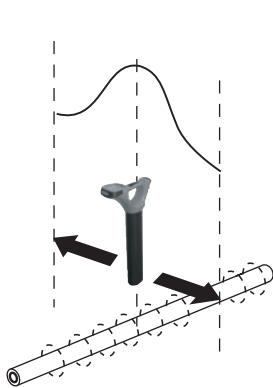

This uses the two horizontal antennas and provides a “Peak” or maximum signal response over the center of the radiated signal from the buried line. The compass line direction indicator shows the direction of the cable (available in Active modes). The color of the compass changed from clear to blue when the receiver is in line with the buried line.

This is the most accurate of the locating modes as both antennas are used to provide a clearly identifiable “Peak”. In the “Peak” mode, a “Peak” signal indicator helps to clarify the position of the “Peak”. This shows the last “Peak” located for a few seconds, enabling the user to return to that position quickly.

3.6.2 Broad Peak Mode

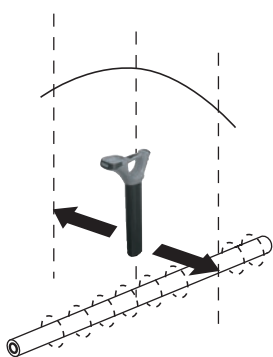

This uses a single horizontal antenna and provides a “Peak” or maximum signal response over the center of the radiated signal from the buried line. The compass line direction indicator shows the direction of the cable (available in Active modes). The color of the compass changed from clear to blue when the receiver is in line with the buried line.

This is less accurate than the twin horizontal antenna “Peak” mode – but is useful if the buried line is particularly deep. For pinpointing the line, the “Peak” mode should be used.

3.6.3 Null Mode

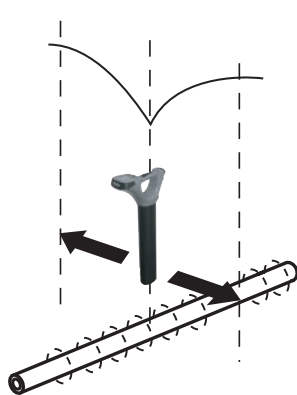

This uses vertical antennas and provides a minimum or “Null” response over the center of the radiated signal from the buried line. The compass line direction indicator shows the direction of the cable (available in Active modes). The color of the compass changed from clear to blue when the receiver is in line with the buried line.

Some users prefer the null response; it works well in uncongested areas, but is more prone to inaccuracies due to distortion of the radiated signal in congested areas.

Left/right indication arrows are also displayed when in “Null” mode. The arrows indicate the direction to move the receiver to locate the position of the buried line.

3.6.4 Sonde Mode

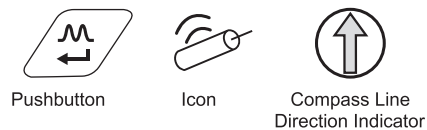
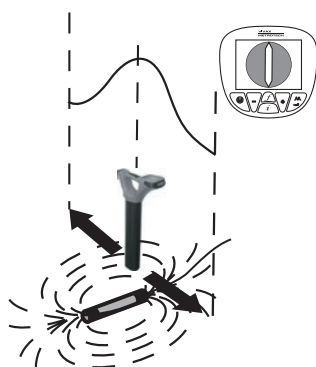

Sonde mode uses the antennas in a “Peak” configuration. An ICON on the display indicates if the receiver is in Sonde mode.

A Sonde is a small transmitting coil that is powered by its own internal battery, or by an external transmitter.

Due to its construction, a Sonde gives a different “Peak” pattern - when locating along the direction of the Sonde - instead of the usual single “Peak”, the Sonde provides three distinct peaks - a small “Peak” - a large “Peak” - a small “Peak”. The Sonde is located under the center of the large “Peak” when located across the direction of the Sonde and it gives the conventional peak response. Note that the Compass Line Indicator points across the line of the Sonde when directly over it and the color of the compass change from clear to blue.

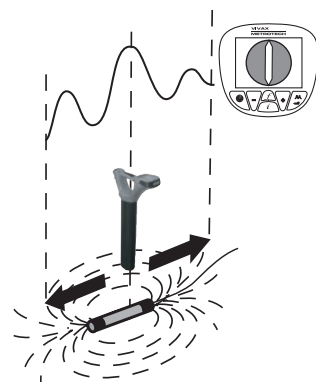

The vLoc-5000 receiver must be used in a different orientation when locating a Sonde – due to the way the signal from the

Sonde radiates. With the front of the receiver pointing across suspected direction of the Sonde – pinpoint forward and backward (across the Sonde) and then move along the line of the Sonde until the maximum peak is located (in other words rotate the receiver 90 degrees from the orientation normally used when locating pipes and cables).

A Sonde is typically used for locating non metallic pipes or ducts, and the camera end of a sewer inspection camera. Low frequency versions (512 Hz/640 Hz) can transmit through some metallic pipes such as cast iron pipes – which are why they are frequently used with sewer inspection cameras.

For using the compass feature to locate Sondes, please refer to 6.1.3.

3.7 Audio



The visual display is also accompanied by an audio response. The output level (volume) of this response is set by entering the “Setup Menu”. Press and hold “i” pushbutton for 2 seconds to enter setup menu. The setup display defaults to volume. Use the “M” pushbutton to toggle through the available options (Off -Low -Med -High). Press the “i” pushbutton again to exit the setup menu. As the loudspeaker uses a significant amount of power, using lower volume can make the battery life of the receiver last longer.

3.8 Sensitivity Control

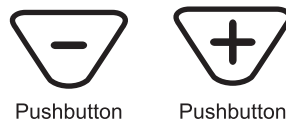

In manual modes, “+” and “-” pushbuttons are provided to increase or reduce the sensitivity of the receiver. If the bar graph moves towards the minimum or maximum a single touch of the opposite pushbutton returns it to approximately 50% deflection. Holding down or repeated pushing of the “+” or “-” pushbuttons increments/decrements the gain.

3.9 Frequency Selection

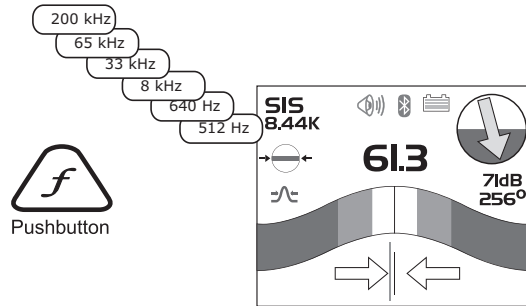

The vLoc-5000 receiver is capable of locating a large number of frequencies or frequency combinations. A list of these frequencies can be accessed using the setup menu. Most of these frequencies listed – you will never use – the setup menu allows you to select the frequencies you wish to use regularly. The frequency select pushbutton on the main receiver pad is used to toggle through the frequencies defined using the setup menu. The operating frequency will be shown at the upper left side of the display. You can change this selection at any time using the setup menu.

The initial frequencies set at the time the unit is supplied are “Power”, “Radio” and the frequencies used by the transmitter purchased. See the transmitter section for suggestions of which frequency is best suited to specific applications.

To select the frequencies you wish to use regularly – enter the setup menu by pressing and holding the “i” pushbutton for 2 seconds. Use the “+” and “-” to select the word “Frequency” – then press the “M” pushbutton to display the list of available frequencies.

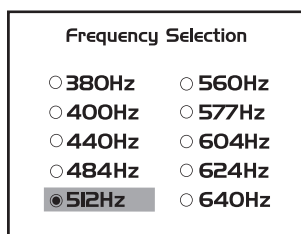

The “+” and “-” pushbuttons are used to navigate the list of frequencies. To add a frequency to the “Frequently used list” press the “M” pushbutton and a dot will appear in the circle alongside the frequency. To deselect a frequency press the “M” pushbutton and the dot will disappear. Once your selection is completed press “i” pushbutton once to return to the setup menu, and again to exit the setup menu.

3.10 Information Pushbutton (Depth & Current)

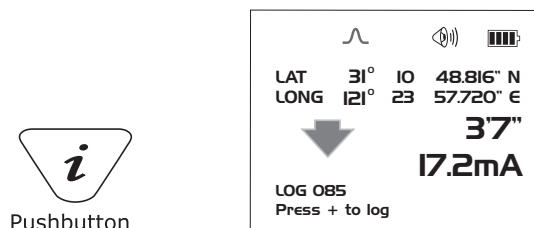

Pressing the “i” (information) pushbutton will display the depth to the center of the radiated signal and a measurement of the current (press the pushbutton briefly – remember if you press and hold – you enter the setup menu. If you do enter the setup menu – press the “i” pushbutton again to return to the locating screen – then try again).

The display shown above shows Long/Lat positional information. This is only displayed when the equipment is paired with a valid GPS system.



IMPORTANT

When locating a cable or pipe (“Line”) – the instrument should be in “Peak” mode and the depth and current measurements should only be taken with the bottom of the receiver standing on the ground and directly in line with the target line.



IMPORTANT

When locating a Sonde – set the mode to Sonde - then the instrument will automatically be in “Peak” configuration. Depth measurements should only be taken with the bottom of the receiver standing on the ground and at ninety degrees to the Sonde.

The accuracy of depth and current readings depends on the quality of the radiated signal being located. If the signal is symmetrical, the depth reading will be accurate to within 5% of the actual depth. If the signal is distorted, depth readings will be less accurate. When taking depth measurement, always hold the receiver at 90° to the ground.

3.11 Information Pushbutton (Setup Menu)



Pushbutton

As described previously, a second function performed by the “i” is to access the SETUP menu. Press and hold the “i” pushbutton for two seconds to display the SETUP menu. Use the “+”, “-” to navigate through the various options and use the “M” pushbutton to select. To exit the setup menu, press the “i” pushbutton.

The setup menu allows the user to configure their personal preference, this menu can be accessed and changed at any time.

Data Logging

The vLoc-5000 has an internal memory that can be used to store location data. It can store in excess of 1000 records.

To store a record first locate a point of interest. Hold the vLoc stationary over the target and press the “i” pushbutton. When in the depth and current screen, press the “+” pushbutton to save the data. The “Log” number indicates the number of records stored.

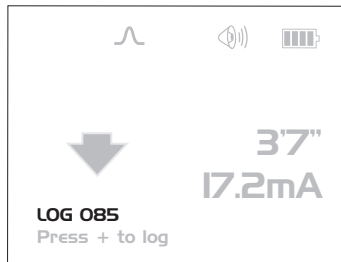

If the GPS function is enabled the GPS coordinates will also be displayed and attached to any saved file.

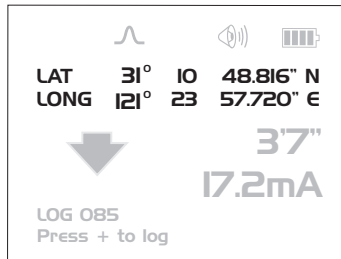

4.1 Bluetooth



4.1.1 Fitting the Bluetooth Module

1. Ensure the unit is switched off.
2. Use a small cross head screw driver to remove the two screws retaining the Bluetooth cover. This is found at the back of the handle near the battery compartment.
3. Remove the cover by sliding it away from the handle.
4. Take the Bluetooth module and carefully slide it into the position the cover was occupying.
5. Replace the two cross head screws.

4 Data Logging

6. Switch on the unit and after a few seconds a grey, Bluetooth icon should appear showing that the module is fitted.
7. If a red line is shown through the icon, this indicates that the Bluetooth module is not enabled. Bluetooth enable is located in the user menu which is accessed using a long press of the “I” button.
8. The Bluetooth can communicate with external devices that are also Bluetooth enabled. There are many Bluetooth enabled GPS devices but Vivax-Metrotech offer the Holux GPS as a suitable solution for those requiring mapping to accuracies better than 5m. For those requiring accuracies better than this, for instance submeter accuracy, the customer should contact a GPS supplier of their choice. However, as a recommendation, one such device that delivers submeter accuracy is the Trimble ProXT.

4.2 Holux GPS Device Overview



The Holux M-1200E is a simple GPS device with integral rechargeable batteries and Bluetooth communications. It can either be mounted in the purpose designed holder from Vivax-Metrotech or can be positioned anywhere within a few meters from the vLoc-5000. For instance using “Velcro” to attach it to the peak of a baseball cap ensures clear view of the sky and satellites.

The best accuracy that can be expected from this device is better than 2.2m. However, this depends on satellite and DPGS satellite availability. It is compatible with EGNOS and WAAS SBAS differential satellite correction systems.

Ensure the battery is charged by either using the cigarette charger lead supplied or attaching it to a USB interface using a standard USB to mini USB lead.

To switch on the M-1200E position the slider switch, located on the side of the device, to the on position. The Bluetooth icon will flash rapidly (approx every half second). This indicates that it is searching for a device to pair with. When the Holux is paired with a device the flashing will change to a slower rate.

The GPS icon will be continuously illuminated indicating that GPS lock is not achieved. When the GPS icon starts to flash GPS lock is achieved.



TIP

For best results allow the GPS indicator to flash at least 15 minutes before commencing a survey.

4.2.1 Pairing with the vLoc-5000 Receiver

1. Switch on the M1200 and ensure it is within a couple of meters of the receiver.
2. Pairing the M1200 with the receiver is achieved through the setup menu. To enter the setup menu press and hold the “i” pushbutton.
3. Press the “+” button to scroll to “Bluetooth Pairing” and press the “M” pushbutton. The vLoc-5000 will begin to search for available devices. At the end of the search, a list will be displayed which should include “HOLUX_M-1200”. Use the “+” and “-” pushbuttons to highlight this device and press the “M” pushbutton.
4. The vLoc-5000 will automatically return to the locate screen. Within 10 seconds the Bluetooth icon will change from grey to blue. This indicates that pairing is successful.

TIP

When not using the Bluetooth function switch off the Bluetooth search function by entering the user menu and deselecting “Bluetooth Search”. This will save battery life and prevent interference from the Bluetooth search activity, in the Radio mode.



When the Bluetooth search function is deactivated a red line will appear through the Bluetooth icon in the locate screen.

5. Next to the Bluetooth icon is the red GPS signal strength bar graph. This will not appear until a valid GPS signal is detected.
6. The bar graph has 4 levels. For best results, allow a few minutes after the bar graph has started before commencing the survey. The accuracy will improve with more bars illuminated.

4.2.2 Gathering Data in Active Modes

Switch on the Holux and ensure pairing as indicated above. (Bluetooth icon should be blue) Wait for a valid GPS signal as indicated by the red bar graph next to the Bluetooth icon.

TIP

It is a good idea to ensure the data log is clear before commencing. To do this press the “i” button. Whilst the depth screen is displayed press and hold the “-” button. The message: “Are you sure you want to delete all this data log. Press + key to Delete” Pressing the “+” key will clear the data log.



4.2.3 Gathering Data in Power and Radio (Passive) Modes

This is done in the same way as in the active modes except that it is not possible to enter the measure mode unless a valid GPS signal is received from the Holux GPS.

Depth and current are not available in the passive modes but all other data can be saved to the datalog.

Locate the cable as described in the vLoc-5000 user handbook.

Momentarily press the "i" button. A screen similar to the below will be shown:

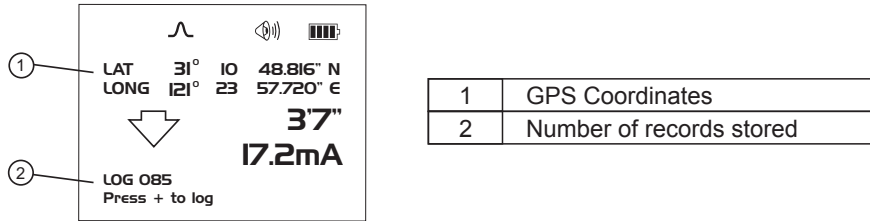

1	GPS Coordinates
2	Number of records stored

To save a record press the + button whilst in this screen.

4.2.4 Transferring Data from the Locator to a Computer

To transfer data it is necessary to use the vLoc-5000 Configurator Tool. This is a simple program that can be downloaded from the Vivax-Metrotech web site at www.vivax-meterotech.com. The file can be found under the Support/Download Library/Others Download.



TIP

To view Google files it is first necessary to install the Google earth application to your computer. This is a free application which can be found at <http://www.google.com/earth/download/ge/agree.html>

4.3 Trimble ProXT/XH



For those wishing to work with accuracies better than 1 meter, the Trimble ProXT/XH provides a simple and cost effective solution. The ProXT operates in a very similar way to the Holux in that it has two LEDs indicating that there is Bluetooth lock and another for GPS lock. Bluetooth pairing is one in the same way as the Holux described above. Data gathering is exactly the same as with the Holux described above.

4.3.1 Trimble ProXT/XH Setting up Procedure

The ProXT can also be configured for different applications so the first time it is used it should be configured to operate with the vLoc-5000 receiver.

Install to your computer the Trimble GPS Controller software. This is a free application and can be found at http://www.trimble.com/pathfinderprox_ts.asp?Nav=Collection-32840

Connect the Trimble ProXT to your computer either by setting up a Bluetooth connection or by using the RS232 lead supplied.

Launch the application and switch on the GPS. When connection is achieved a little satellite icon will appear in the middle of the top bar.

4 Data Logging

1. From “Skyplot” select “Setup”.

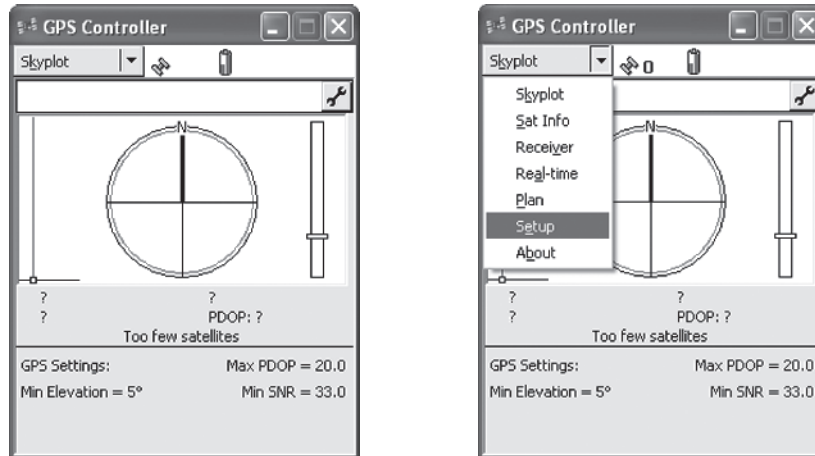

2. Now select “GPS Settings”.

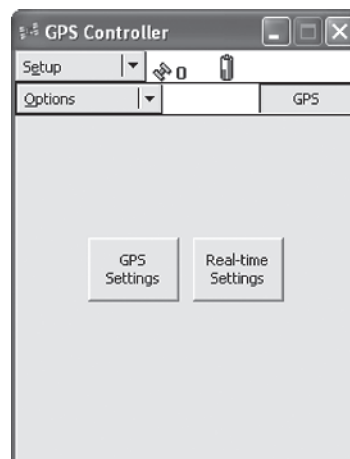

3. Select COM1 and set the parameters as below and then press OK.
4. Now select the spinner on the “NMEA Output” line.

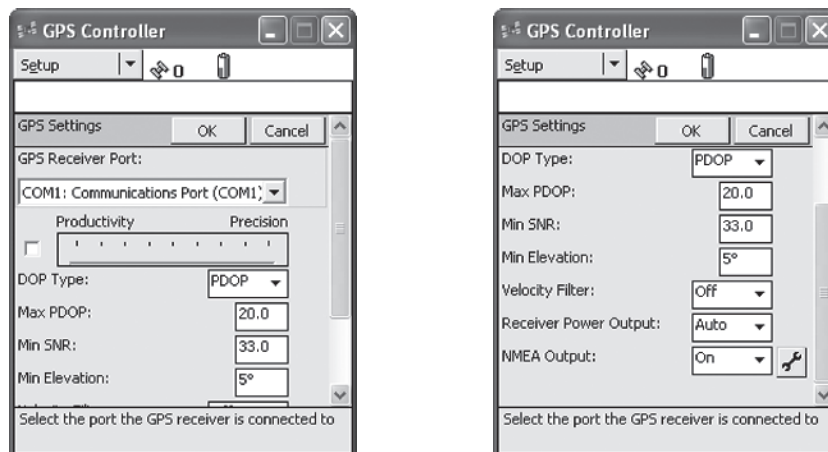

4 Data Logging

5. Set the following parameters:

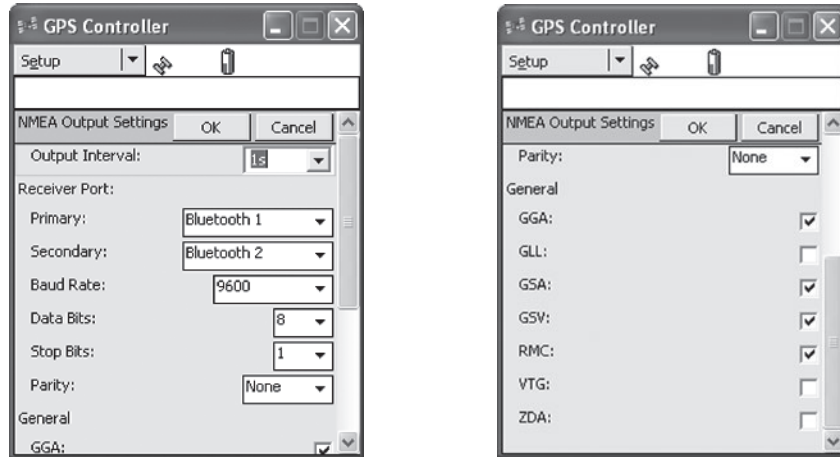

6. Press OK to save parameters to the GPS.
7. These parameters are suggested values. Experienced users may decide to alter them to suit the particular requirements of an application.
8. Pairing with the vLoc receiver is similar to the Holux described previously. Data gathering is also similar to the Holux procedure.

4.3.2 Transferring Data from the vLoc-5000 to a Computer

To transfer data from the vLoc-5000 receiver to a computer requires the use of a simple free of charge software package MyLocator2. It can be downloaded from the Vivax-Metrotech web site www.vivax-metrotech.com.

4.4 MyLocator2

MyLocator2 configuration tool is a software package that enables the operator to configure the vLoc-5000 of locators. The software is compatible with Window XP, Vista and 7. To install, use the link on the Vivax-Metrotech web site and follow the installation instructions. A MyLocator2 shortcut icon will appear on your desktop. MyLocator2 is also used to transfer data from the locator to a host computer.

MyLocator2 is under continual development so the following is a guide to its operation but there may be subtle changes to screens etc. However, the guide should still give sufficient information for the user to navigate MyLocator2.

4.4.1 Launch the Application

To launch MyLocator2, double click on the MyLocator2 shortcut icon. If the host computer is connected to the web, it will check to see if MyLocator2 is the latest version. If it is not, it will ask if you wish to install the latest version. Follow the instructions if you wish to install the new version.

MyLocator2 can be operated on different levels. Each level enables different features and

4 Data Logging

functionality. Some levels require a dongle to operate. Dongles are available from Vivax-Metrotech.

In its basic form it allows the operator to:

- Check the software revision number and download the latest version. This feature is useful where software changes have been made to enhance existing features and to install new free of charge features as they become available.
- Upload data files. Files that have been saved in the equipment such as location/GPS data can be transferred to a PC using MyLocator2.
- Adding flash screens: The user can add pictures or company logo's of his choice to the startup screen.

The basic operational screen is displayed below. This will change slightly depending on which tab is active.

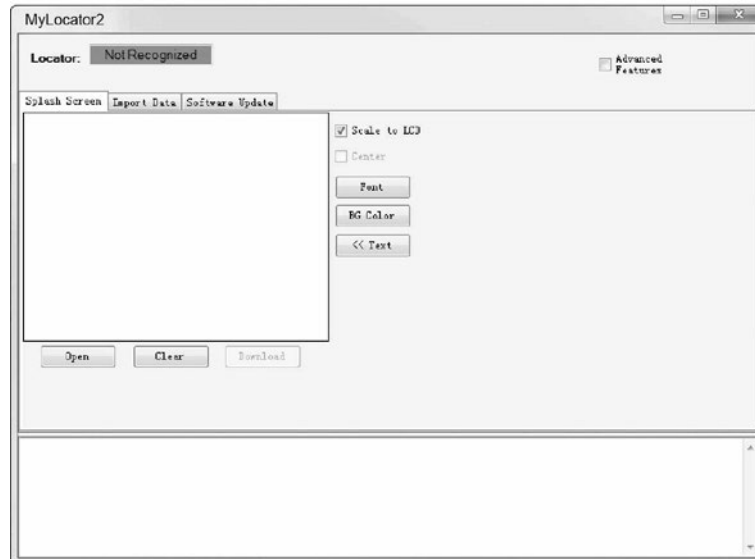

Connect the vLoc receiver to the PC using a USB to Mini USB cable. The PC should recognize the vLoc and the display will now change to the below or similar.

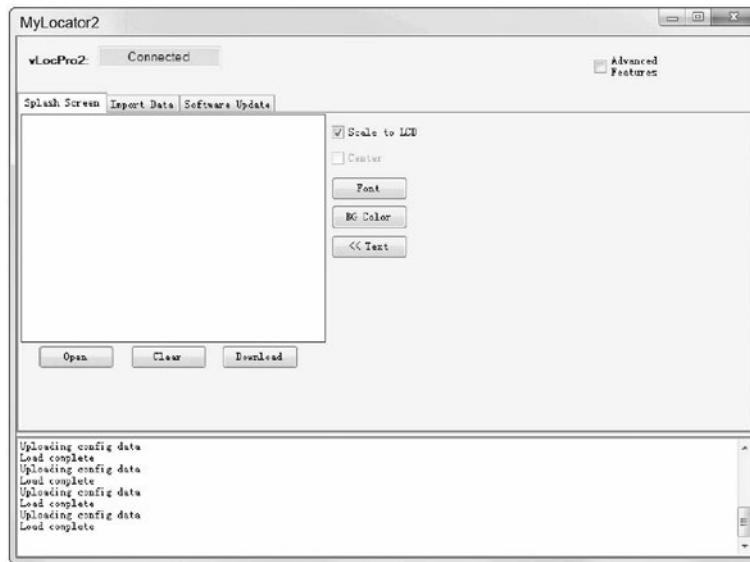

It will now be possible to perform the three operations in the tabs shown.

4.4.2 Splash Screen

1. Click the Splash Screen tab. Click on the “Open” button. Browse your computer to find the picture that is intended to be the splash screen.
2. The software will accept the following formats: JPEG, BMP, GIF, PNG, ICO.
3. Select the file and open. The screen below should now also contain a representation of the picture.
4. Press “Download” to transfer the file to the vLoc or “Clear” to remove the file.
5. Clicking on “Scale to LCD” will alter the aspect ratio of the picture to fully fill the screen. Leave this unchecked if no scaling is required. Check the “Centre” button to center the graphic on the screen.

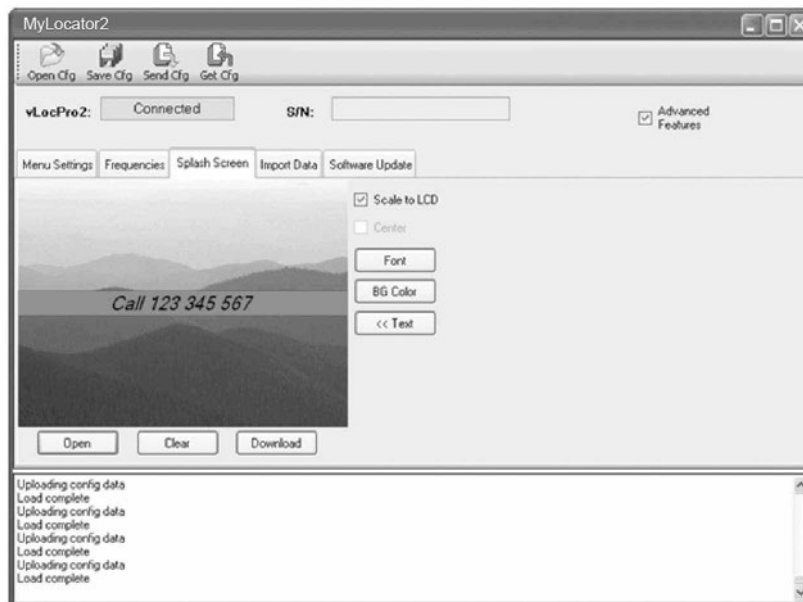

4 Data Logging

- Text can also be added to the flash screen.
- Use the “Text”, “BG Color” (Background color) and “Font” buttons to add text to the startup flash screen.

4.4.3 Upload Data Files

- Click on the “Import Data” tab. A screen similar to the one below should be shown.
- Select your preference for Date, Time and Distance.
- Click on the “Import Data” button.

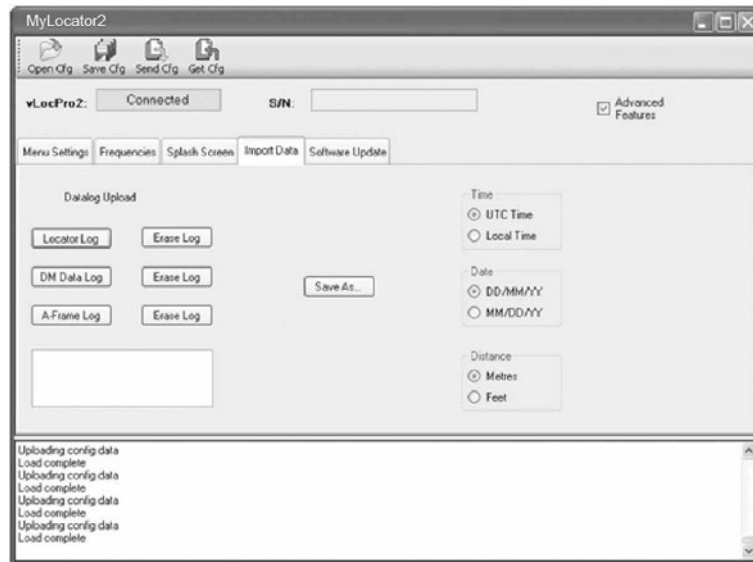

- When the upload is complete (Should only take a second or two) it will be possible to save the data.
- Press the “Save As” button.
- Browse your computer files to find the desired file location. Name the file and use the “Windows” pull down tab to select the desired file type. (.xl, .txt, .shp or .kml)
- Press the windows “save” button.
- Use the “Clear Log” button to clear the log from the locator. Note that this can also be achieved by using a long press on the “-” pushbutton on the locator, when in the depth & current screen.

4.4.4 Software Update

1. With the locator switched on and connected to the computer, click on the “Software Update” tab.
2. A screen similar to the one below should be shown.

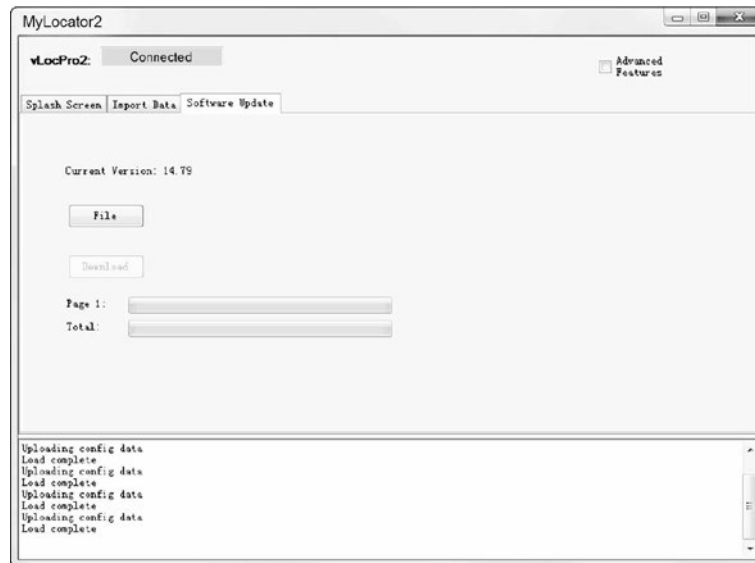

3. If connected to the Web, press the “Get latest swrev” button. Alternatively, if the software revision required is already saved, use the “File” button to browse to the relevant file.
4. Click on the “Download” button. The progress bars below will start to activate showing the progress of the software installation. When it is complete a message “software upload complete” will be shown both on the computer and locator screen.
5. Note that the new software will not be active until the unit has been switched off and on again.

4.4.5 Advanced Configuration Tool

Clicking the “Advanced” button allows the user to configure the instrument to specific requirements.

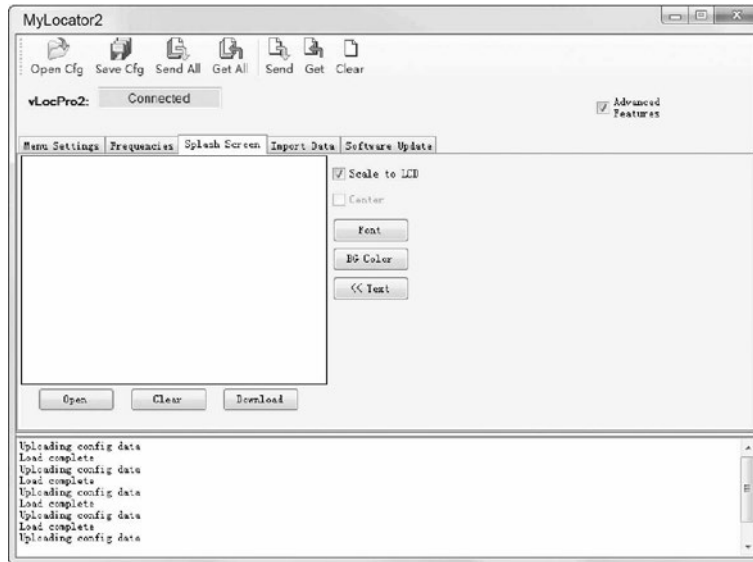

The extra features available are:

- Switch on or off user menu settings
- Switch off frequency selections

By doing this the locator is simplified and tailored exactly to the customer requirements.

The configuration can be saved as a “configuration” file and used to configure other vLoc-5000 locators. This ensures consistency throughout the locator fleet.

4.4.6 Switch On/Off User Menu Settings

1. With the locator switched on and connected to the host computer click on the “Menu Settings” tab.
2. A screen similar to the one below should be shown. If not, click on the “Get Cfg” icon on the top bar. This will load the configuration of the connected locator to the host pc.

4 Data Logging

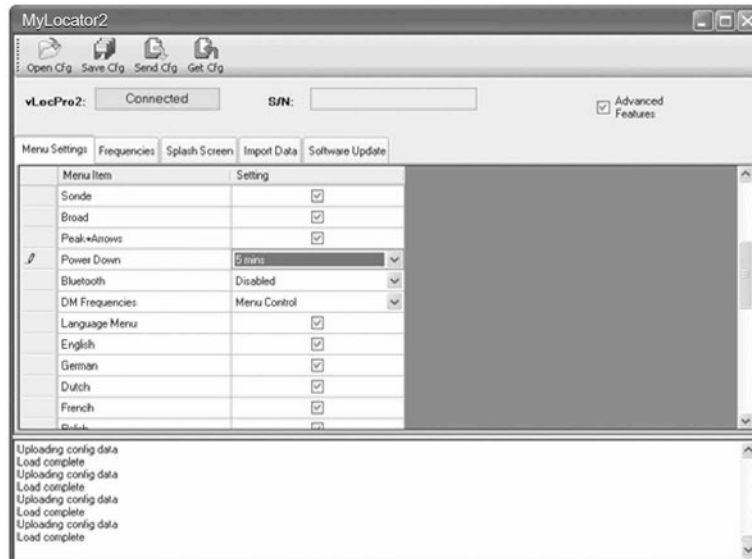

3. Check the boxes that are required to be made available.
4. Click on the pull down menu and select the settings required.
5. Clicking on the “Send Cfg” icon will send the configuration to the locator.

4.4.7 Switching On/Off Frequency Selections

1. Click on the “Frequencies” tab. A screen similar to the one below should be shown.

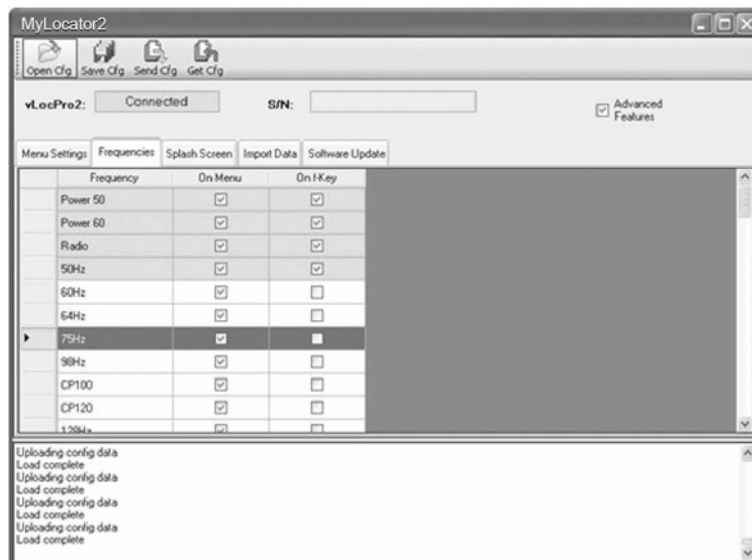

2. Each row is color coded:
 - a. **Grey** indicates that frequency is not selected for either the menu or the frequency key.
 - b. **White** indicates that the frequency will be active in the locator menu but has not been selected to show on the frequency key. (Note that it is still possible to make this frequency available on the locator by selecting it in the locator frequency menu.)
 - c. **Green** indicates that the frequency will be available both in the locator menu and frequency select key.
 - d. **Blue** shows active line.

4 Data Logging

3. Make the selections required.
4. Clicking on the “Send Cfg” icon will send the configuration to the locator.

4.4.8 Saving a Configuration

Having created a configuration it is possible to save this for future use.

To save a configuration:

1. Click on the “Save Cfg” icon.
2. Browse to a desired file location.
3. Create a name for that file, the extension will be: filename.vmcfg.
4. Press “Save” in the window.

To retrieve the file:

1. Click on the “Open Cfg” icon and browse to select the desired file.
2. Click on “open” in the window.
3. The file will populate the MyLocator2 screen automatically with the settings from the configuration file.

4.4.9 Configuration Lock Dongle

A Configuration Lock dongle is available that allows “lockout” of features and functions so that operators are forced to use particular settings. The dongle is also used to unlock these features.



To activate the dongle, plug it into any USB socket on the host computer.

With the dongle active, the MyLocator2 screen will look similar to the picture below.

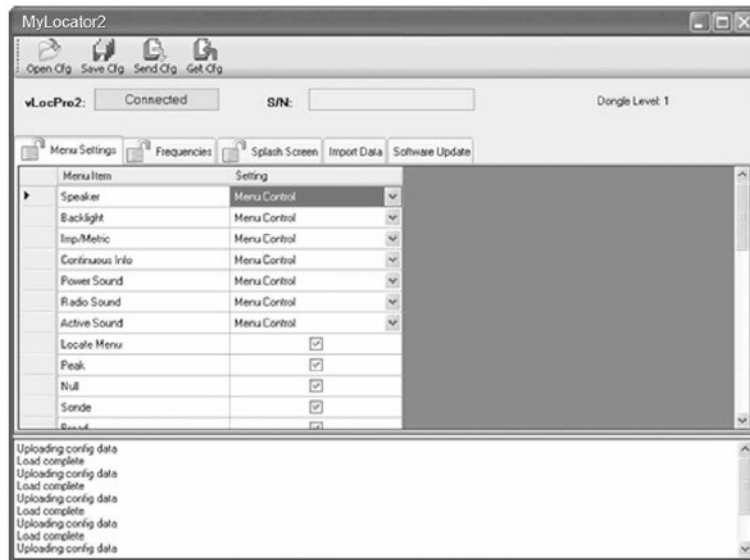

Note the padlocks on the three tabs, Menu Settings, Frequencies and Splash Screen.

When a locator is configured with these locks activated, the menu and frequency options in the locators user menu will not appear, stopping the user from altering the settings downloaded to the locator by the Dongle activated MyLocator2 facility.

To activate the padlocks simply double click on the desired tab.

The features can only be re activated by connecting to a host computer with MyLocator2 which has been dongle activated. Double click on the padlocks as before to unlock them and download the changes to the locator.

Example use of the Dongle Lock:

Supposing the Dongle User wishes to force the user to only use 8kHz Peak Mode. The operation would be:

1. Connect the locator to the host computer and switch on. Launch MyLocator2.
2. Click on the “Get Cfg”. This will populate MyLocator2 with the Locators configuration.
3. Click on the “Frequency” tab.
4. Uncheck all frequencies except 8.19kHz.
5. Check both boxes associated with 8.19kHz as below.
6. Double click on the Frequency tab to lock the padlock.

4 Data Logging

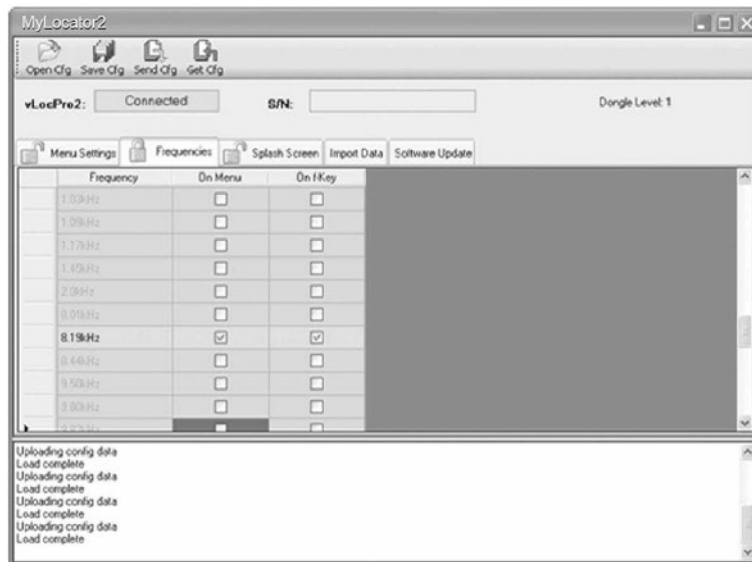



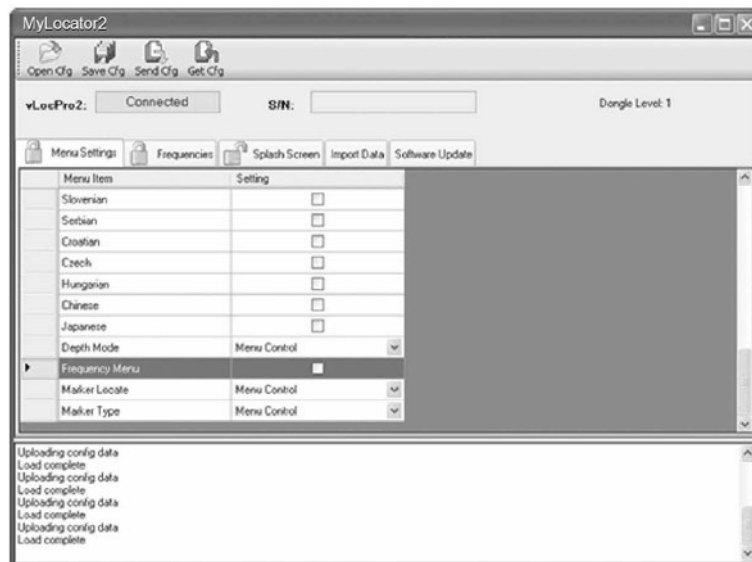

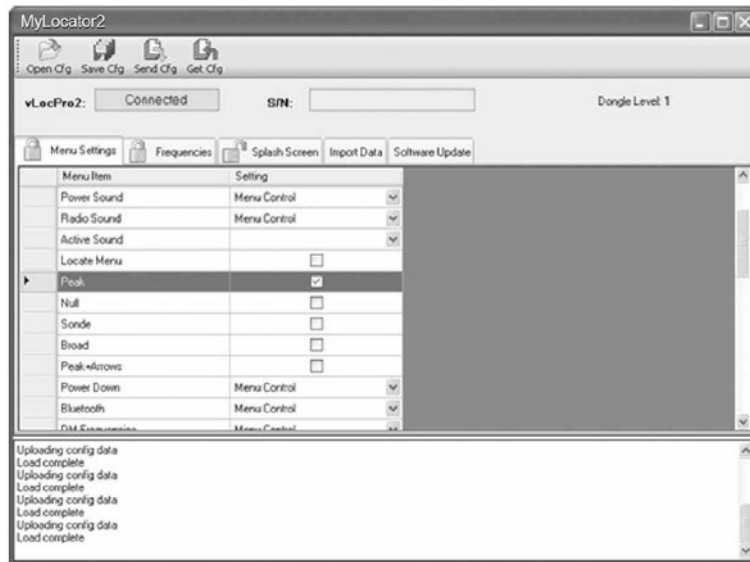
7. Now click on the “Menu Settings” Tab
8. Uncheck the Frequency and all antenna modes except “Peak” as below. Note also the Locate Menu box is un-checked; this will prevent the function appearing in the user menu.
9. Double click on the “Menu Settings” tab to lock the padlock.
10. Now click on the “Send Cfg” icon to send it to the locator.
11. To activate the new configuration switch the locator off and on.





4.4.10 Icon Summary

Icon	Function
 Open Cfg	Opens a previously saved configuration.
 Save Cfg	Saves a configuration created by the operator to a file of your choice.
 Send Get	Either "Send" (saves) configuration to a locator or "Get" (copy) a configuration from a locator.
 Clear	"Clears" a configuration created on the configuration tool.

Loc-10TxSIS Transmitter

5.1 Loc-10TxSIS Transmitter Overview

The Loc-10TxSIS transmitter is a rugged portable transmitter powered by alkaline “D” cells or Ni-MH (Nickel Metal Hydride) rechargeable batteries. The following describes the features and uses of the transmitter.

Display

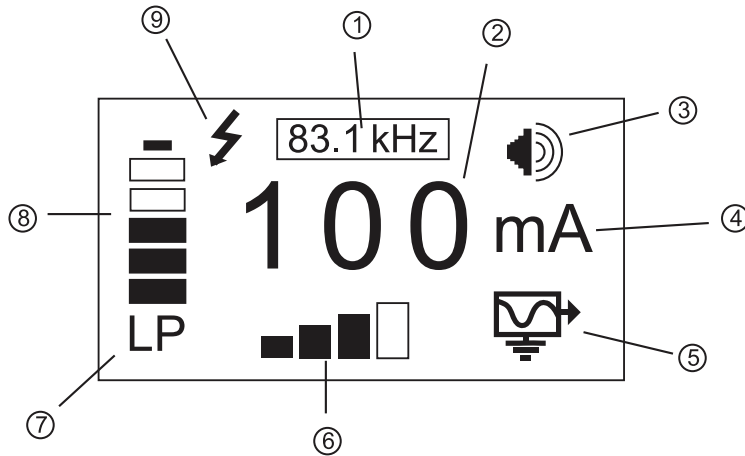

1	Frequency Being Transmitted (200 kHz available in some country)	6	Output Setting (Step) (filled box indicates current level has been reached, empty box indicates requested current level has not been achieved)
2	Digital Read Out (mA, volts, ohms)	7	Low Power Indicator (enabled automatically when battery becomes one bar)
3	Loudspeaker Level	8	Battery Status
4	Units (mA, volts, ohms)	9	High Voltage Warning (output is enabled for high voltage)
5	Mode Indication		

*High Voltage Warning - the transmitter checks the line when connected, if the line is carrying in excess of 35V, it will display “high voltage” warning icon and not allow the transmitter to operate. In addition the transmitter is protected by a 1.25A/250V fuse in the event of excessive voltage or voltage spikes on the line.

Pushbutton

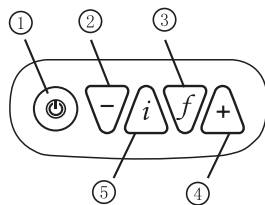

1	On/Off Control
2	Output Decrease
3	Frequency Select
4	Output Increase
5	Information (Volume, mAmps, volts, ohms)

Connections

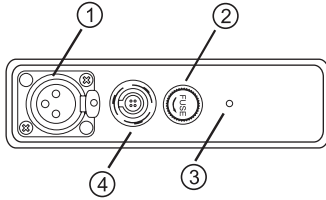

1	Output Connection
2	Output Protection (Fuse)
3	Loudspeaker
4	Battery Charging Socket & DC Input

5.2 Transmitter Battery



In most markets the transmitter is shipped with alkaline batteries (12 x D cells) unless rechargeable batteries are specified. Batteries are fitted into quick release trays – the alkaline is an open pack, to enable the batteries to be changed. The rechargeable pack is a sealed unit containing Ni-MH (Nickel Metal Hydride) batteries. These packs can only be fitted in a manner to ensure that the alkaline batteries cannot be inadvertently charged.

5.2.1 Removing the Battery Tray

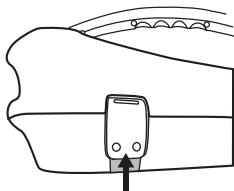

Push up button

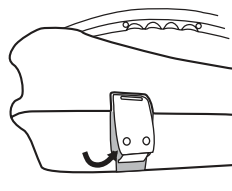

Pull out bottom of catch

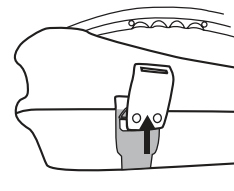

Lift up catch until it clears catch plate

5.2.2 Replacing the Alkaline Battery

- To access batteries – undo stainless steel screws on each battery cover
- To remove batteries – turn tray upside down and give a short sharp tap of the battery tray on your hand
- Replace batteries with new batteries of the same type, be sure not to mix old and new batteries
- Do NOT use rechargeable batteries in the alkaline battery tray. Ensure that batteries are inserted the correct way (see label and molded “+” and “-” in the bottom of the tray)
- Refit the battery cover – then refit the battery tray



WARNING

Alkaline Batteries – insert alkaline batteries (x12) as shown:

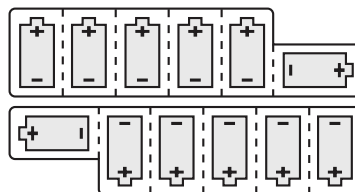

5.2.3 Rechargeable Batteries

- Do NOT attempt to replace the rechargeable batteries or remove battery covers – return to Vivax-Metrotech or a Vivax-Metrotech approved service centers for replacement.



WARNING

Use only Vivax-Metrotech recommended charger.

5.2.4 Re-fitting the Battery Tray

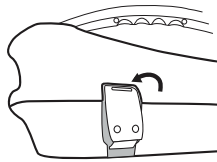

Place top of catch over catch plate

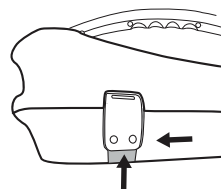

Push up button underneath the catch – where holding that up push in the bottom of the catch. You will hear a positive “click” (Do NOT force catches)

To close battery tray – slid transmitter (TX) onto tray, it will locate itself in the correct position, then close the catches.



WARNING

Power “IN” socket

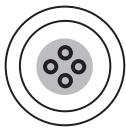

Two pins are used for power in from charger (to charge rechargeable batteries).

Two pins are used for power from external 12V DC source. A 12V DC power cable is supplied and is designed to be connected to an automobile cigarette lighter socket.

Contact Vivax-Metrotech or a Vivax-Metrotech approved service center for wiring diagram of plug, if attempting to repair any of the “charging” leads.

5.2.5 Battery Charging and Disposal

Follow instructions detailed in the General Safety & Care portion of this document.

Only use the battery charger supplied. Using a non approved charger may damage the battery pack and could cause overheating.

To charge, the batteries must be connected to the transmitter. Connect the mains charger to the charging socket on the side of the transmitter and connect the charger to a suitable mains socket.

The LED will show a red light indicating that the charge cycle is in progress. When the batteries are fully charged the LED will change to green.

**NOTE**

Rechargeable pack cannot be charged from a 12V DC source.

5.2.6 Battery Condition Indication

The battery condition (charge) is displayed on the left side of the display, in the case of the rechargeable batteries the condition is also indicated on the charger (red/green light).

5.3 Transmitting Modes

The transmitter has three transmitting modes, which are selected automatically.

5.3.1 Induction Mode (Only on selected frequencies and not SIS frequencies)

This uses an internal antenna to induce a locating frequency onto the target pipe or cable (line). “Induction” mode is automatically selected if no connection accessories are plugged into the “output socket”. An icon indicating “Induction” mode shows on the display. The icon flashes when the transmitter is transmitting. In order to generate successful induction, the transmitter should be positioned over and with the handle in line with the target line.

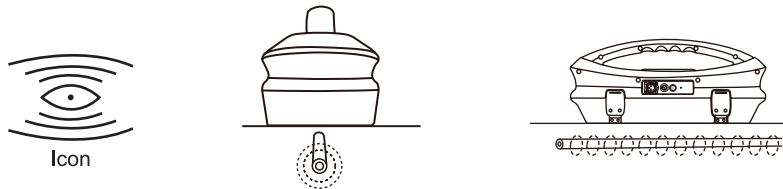

“Induction” mode is generally used when no access is available to make a direct connection, or a clamp connection. When using induction it is very likely that the signal being induced onto the target line will also be induced onto other lines in the area, and onto above ground features such as wire fences. This can influence the accuracy of the location, depth and current measurements. “Induction” mode is also the least efficient way of applying the transmitting signal to the target line. The distance located with “Induction” mode is generally much less than that achieved with a direct connection or clamp connection. “Induction” mode generally works better in higher frequencies, 33 kHz, 65 kHz and either 83.1kHz or 200kHz (depending on region). The advantage of induction is that no access is required to “connect” the transmitter, making it a very quick process. The antennas on the transmitter are tuned to induce specific frequencies or range of frequencies. Therefore only a limited number of frequencies can be selected in “Induction” mode.

**NOTE**

For accurate location and depth measurement the locator receiver should be used no closer than 50ft(20m) from the transmitter.

5.3.2 Direct Connection Mode

By plugging in a connection lead to the output socket, “Direct connection” mode is selected. An icon confirming this is shown on the display. The icon flashes when the transmitter is transmitting. The direct connection lead consists of two cables, one (red clip) must be connected to the conductor being located, the other (black clip) to a suitable ground (a ground stake is provided with the transmitter). An auxiliary groundlead is also supplied. If the auxiliary ground lead is used, the ground clip of the connection lead (black clip) is attached to one end of the auxiliary ground lead.

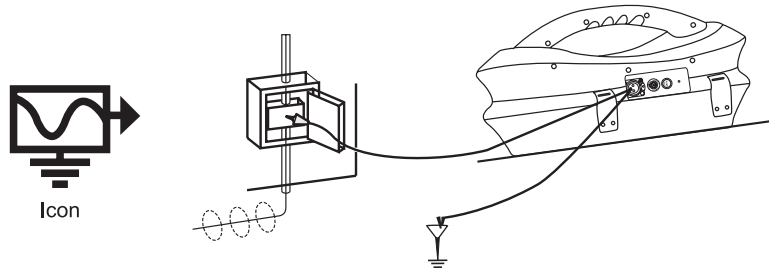

Wherever a direct connection can be safely made without the risk of injury, damage to customer’s plant, or the transmitter, it is the best way of applying the transmitter’s signal.

The coupling of the transmitted signal to other pipes and cables in the area will be much less than with induction, although where commonly bonded systems are encountered – coupling cannot be avoided.

The positioning of the ground connection can also influence the degree of coupling experienced. Ground connections generally should not be made to other pipes or cables, or above ground metallic structures such as wire fences. In general the lower the frequency is, the further the signal will travel, and the less signal coupling will occur. The most common frequencies used for direct connection are between 512Hz/640Hz and 8 kHz.

Regulations in many countries require that power output is limited above certain frequencies. The Loc-10TxSIS enables frequencies below 45 kHz to be transmitted using as much as 10 watts output, but frequencies over 45 kHz are restricted to 1 watt. Using direct connection and the higher power at the low frequencies helps significantly in achieving greater location distances. Direct connections should not be made to cables carrying greater than 35 volts (or as your safety practices allow). The transmitter is protected (250V fuse) from stray currents that may exist on the target line.

5.3.3 Clamp Mode

Plugging the signal clamp supplied by Vivax-Metrotech into the output socket will place the transmitter in “Clamp” mode. An icon confirming this is displayed on the display. The icon flashes when the transmitter is transmitting. When using the clamp no ground connection is needed.

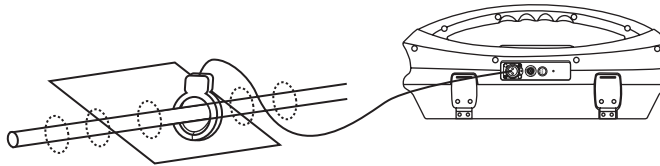

The clamp again is a precise way to apply the locating signal. It is generally used when access to the conductor cannot be achieved to make a direct connection (but there is sufficient access to place the clamp around the cable), or when it is not safe to make a direct connection because the target cable is carrying electricity.

The clamp is a specialized inductive device (sometimes known as a toroidor coupler). All clamps are optimized to work at specific frequencies. In most cases clamps are designed to be used at up to three frequencies only, generally between 8 kHz and 85 kHz. The transmitter will only allow the selection of a suitable frequency for your clamp.



WARNING

When applying the clamp to cables that carry electricity – be sure to follow your company’s safety instructions and procedures. Beware that if applied around a high voltage cable – that cable may induce a current in the clamp causing it to snap shut or jump quite dramatically – always apply clamps carefully.

5.3.4 Connection Block

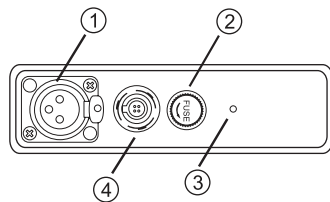
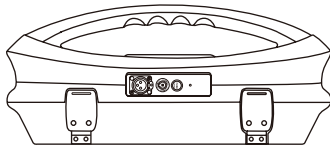

1	Output Connection
2	Output Protection (Fuse)
3	Loudspeaker
4	Battery Charging Socket & DC Input

All the connections made to the transmitter are made at the connection block except for a USB socket which is mounted inside the battery compartment and is used for programming the transmitter’s processor.

The connection block consists of:

- Output (XLR) socket – for the direct connection lead and clamp.
- Charger socket (to allow the retrofitting of a rechargeable battery pack – the charging socket is present even if re-chargeable batteries have not been purchased).
- Transmitter 12V DC power lead used to power the transmitter from a vehicle (NOT for charging).

- Fuse – this protects the transmitter circuitry in the event of the transmitter receiving up to 250V incoming on the output leads.
- A beeper is positioned behind the small hole.

5.3.5 Frequencies and Power Output

The Loc-10TxSIS transmitter is supplied with a predefined set of transmit frequencies.

Standard frequencies are:

- 512Hz (where electrical systems are 60Hz) direct connection – 10 watts.
- 640Hz (where electrical systems are 50Hz) direct connection – 10 watts.
- 65 kHz direct connection – 1 watt.
- 83.1 kHz, 89kHz, 131kHz direct connection – 1 watt (depending on region).
- 200 kHz direct connection – 1 watt (depending on region).
- Induction frequencies are 8 kHz, 33 kHz and 65 kHz or alternatively 33 kHz, 65 kHz and 200 kHz (Note: 200 kHz is not permitted in some markets). Other combination between 8kHz, 33kHz, 65kHz, 78kHz and 200kHz also available. For detail please refer to Loc-10TxSIS data sheet.
- Other frequencies with 10 Watt output:
 - Direct connection: 256Hz, 491Hz, 512Hz, 982Hz
 - Direct and clamp connection : 8.19kHz, 8.44kHz, 9.5kHz, 9.82kHz, 32.8kHz, 38kHz

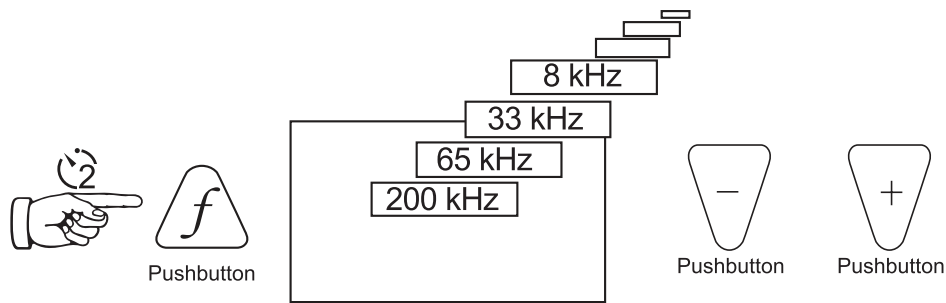

As with most manufacturers the clamps and induction antennas are tuned to specific frequencies, and do NOT work over the complete range.

Frequencies are selected by pressing the “f” pushbutton which toggles through the available frequencies for the selection mode. The frequency is automatically selected if you don’t toggle past it within 2 seconds. The frequency is shown on the display.

The output current is shown in large characters on the display – to increase or reduce the power output press “+” or “-”. The vertical bar graph at the bottom of the display indicates which of the four current output steps is being used. If the transmitter can supply the requested current, the bar will turn black. If the bar does not turn black, improving the ground connections or wetting the ground where the earth stake is positioned, may help. However, it may not be able to achieve the current setting requested because the impedance of the line is too high for this setting. If this happens it is best to select a setting that has a black bar, this will ensure a stable output.

The current being transmitted will be limited by the impedance of the cable, therefore it is not unusual to increase the output level, but see no increase in the current displayed. This is not a fault with the transmitter.

The transmitter will always revert to first level output when switched on –this is a power saving feature – in most circumstances this output level is sufficient. Increasing the output power unnecessarily will reduce the battery life unnecessarily. All other settings remain the same as the last setting used.

5.3.6 Most Used Frequencies (Frequency Selection) Feature

This feature can be used to allow operator to choose his most used frequencies from a list of possible frequencies. Once these frequencies are selected in the main menu, pressing the "f" pushbutton, user can scroll through them. At any time user can add or remove frequencies from the above list, following the below procedure. Maximum frequencies that can be appear in most used frequencies list is 14.

The advantage of this feature is that user can optimize the transmitter and activate at the main menu user’s preferred frequencies, instead of having a whole list offrequencies that user has to scroll through.

To enter the "Frequency Menu"proceeds as follows:

1. Pressthe "i" pushbutton 5 times to get to the "Frequency selection" sub-menu.

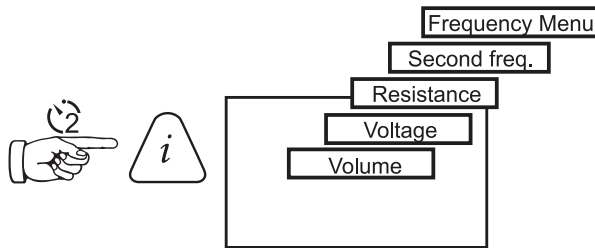

2. Screen will show a list of frequencies available, with the central one in a box.

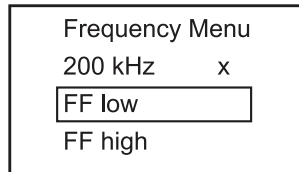

3. Pressing the "+" or "-" pushbuttons, you can scroll up or down through the available frequencies.

- Once the wanted frequency is inside the box, press "f" pushbutton to select or deselect the frequency. An "x" will appear in the box for a selected frequency.

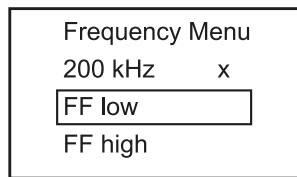

- After selecting for the frequencies, press the "i" pushbutton again to exit the "Frequency Menu" and the selected list of frequencies can be select from the main display screen.

5.3.7 "Dual frequency" Mode

This feature can be used when user wants to energize on user's target two frequencies at the sametime. Mainly, it can be used when user is not sure which frequency can be impressed better into the target.

NOTE



- When using "dual frequency" mode, total power will be split between the two activated frequencies.
- This mode of operation is available only for frequencies below 40 kHz.
- The two frequencies have to be available in the main menu.

To enter the "Choose Second Freq." menu, proceeds as follows:

- Press "f" pushbutton to select the lowest frequency that user want to have in the dual combination.
- Press "i" pushbutton 4 times to get to the "Choose Second Freq." sub-menu. The above frequency will be shown in a box.

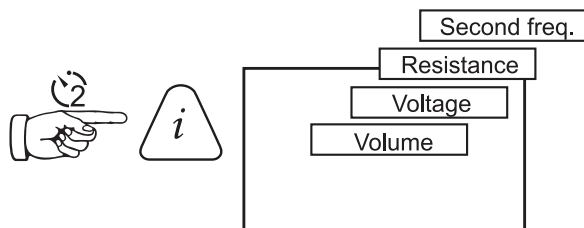

- By using the "+" and "-" pushbuttons, user can scroll through the available frequencies and bring the wanted one in the box.

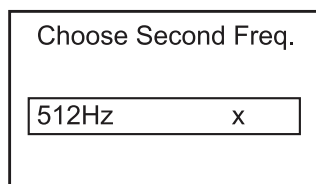

- Press "f" pushbutton to select the second frequency and exit the submenu to return to the main display.
- In the main display screen, both frequencies are displayed. The frequency will toggle between the two chosen frequencies.

NOTE



If user is changing the selected frequency by pressing the "f" pushbutton, this mode will be deactivated. To reactivate it, user has to follow again the above procedures.

If the unit is powered down, this mode will be reset. To activate it again after power up, user has to follow the above procedures.

5.4 Information

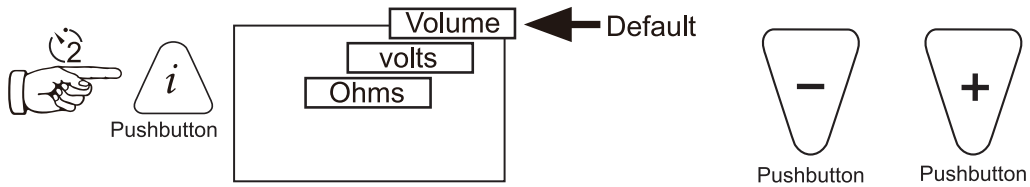

When the "i" (information) pushbutton is pressed, the display will show the volume level of the audio; use the "+" and "-" pushbuttons to increase/reduce the volume or turn the beeper off (off – low – medium – high).

By pressing the "i" (information) pushbutton the display can be toggled to show "voltage" and "resistance". The display indicates mA, as the default, and volts or ohms when selected.

Using the vLoc-5000

6.1 Using the Receiver

6.1.1 Line Locating

Line locating is when a pipe or cable is being located. When line locating, the receiver should be held with the display forward, and then swept to the left and right across the suspected direction of the buried line. Note the compass line direction indicator always points in the direction of the line (active in active modes). The compass color change from clear to blue when the receiver is in line with the buried line.

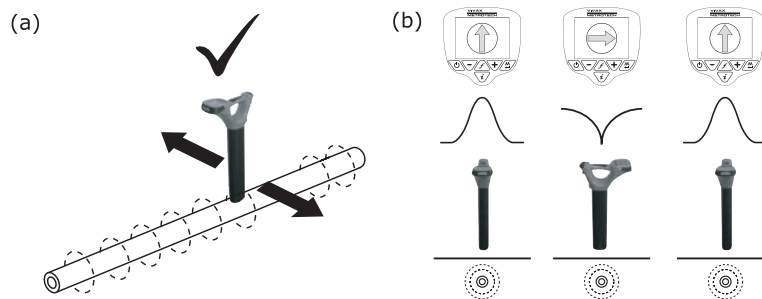

The receiver should be kept parallel to the ground – and should not be flipped up at the end of each pass. See diagram (a).

To establish the direction of the cable – use whatever mode you prefer to locate the line; then switch to “Peak” mode to confirm the direction. Pinpoint the line – by carefully establishing the exact “Peak” position. Then (with the base of the receiver on the ground) rotate the receiver through 90 degrees, as you do this the signal being received will reduce substantially (possibly disappear). Then rotate the locator until you find the maximum “Peak”. The front of the locator is again facing in the direction of the buried line. See diagram (b).

6.1.2 Depth & Current Measurement

Pinpoint the exact position of the cables as follows:

- Locate lateral position of the cable.
- Rotate receiver to confirm the direction of the cable (you will see a null response when the receiver is intersecting the direction of the cable at 90 degrees).
- Rotate the receiver back until it is exactly in line with the cable.

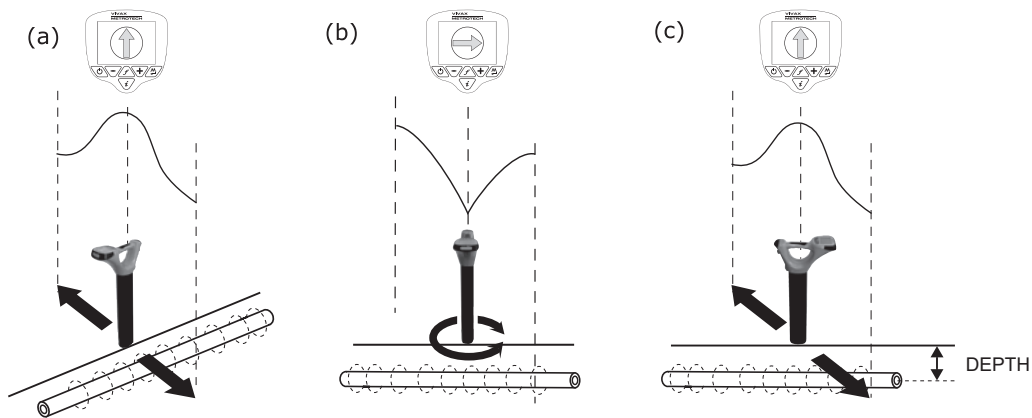

- Once the position and direction of the cable has been established, stand with the base of the locator on the ground – with the locator in the absolute “Peak” position (over and in line). Then press the “i” information pushbutton briefly, the current and depth will be displayed.

6.1.3 Sonde Location

This is used for locating a Sonde only. A Sonde is a transmitting coil and the signal radiates in a different manner than that of a line (see diagram b).

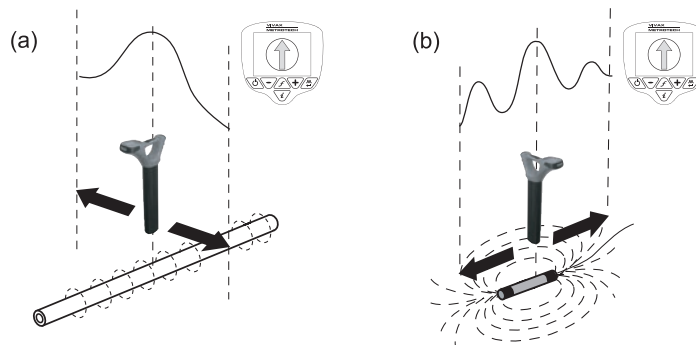

Due to this construction, the Sonde gives a different “Peak” pattern (see diagram b) – note that there are 3 distinct peaks – a small peak – a large peak – a small peak. The Sonde is located under the center of the “large peak”, when locating across the direction of the Sonde it provides the conventional peak response. Note also that the Compass Line Indicator points across the line of the Sonde when the receiver is directly over it and the color of the compass change from clear to blue.

A Sonde is typically used for locating non metallic pipes or ducts, and the camera end of a sewer inspection camera. Low frequency versions (512Hz/640Hz) can transmit through some metallic pipes such as cast iron pipes – which is why they are frequently used with sewer inspection cameras.

The procedure for Depth Measurement is the same as in line location, but must be done in the Sonde mode. Depth measurements taken from a Sonde in any mode other than Sonde mode will be inaccurate.

6.1.4 Using the Compass Feature to Locate Sondes

Switch on the vLoc-5000. Select the frequency to match the Sonde frequency. Use the mode pushbutton to select Sonde.

Stand in the approximate vicinity of the Sonde. Press the “+” pushbutton to increase the gain so that a steady bar graph reading is displayed. If no or very fluctuating bar graph is shown, it means that the Sonde is not in the expected vicinity. If this is the case pull back the Sonde to a known position, which may be the point the Sonde enters the pipe, and start the search here.

Rotate the locator until the compass is pointing at 12 o'clock. Walk in the direction of the compass keeping the compass pointing at 12 o'clock. The locator will lead you in an arc that crosses over the Sonde. Press the gain pushbuttons to keep the bar graph on scale. The maximum bar graph indicates the position of the Sonde.



To pinpoint the Sonde, find the peak in both directions.

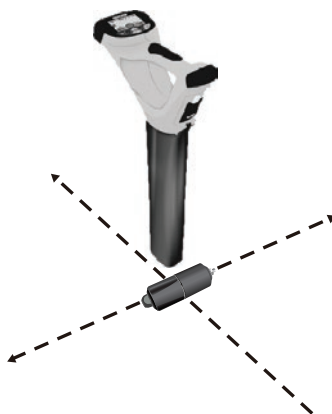

When over the peak position, the depth is automatically displayed. Press the “i” pushbutton to get a more precise depth reading.

TIP

Using the compass to locate the Sonde requires free space to walk to the side of the Sonde. If there is an obstacle such as a wall or vehicle that restricts walking in an arc, the following method can be used.

- Position the locator in the approximate vicinity of the Sonde as above.
- Rotate the locator so that the compass is now pointing at 3 o'clock.
- Now step to the side keeping the locator pointing in the same direction. The compass will rotate slightly.
- Keeps the locator pointing in the same direction and walk forward. The compass will slowly rotate. When it reaches 12 o'clock follow the compass keeping it at 12 o'clock.



Pinpoint the Sonde as in the first procedure.

6.2 *Passive or Active Location*

There are two types of location method available with this system, they are:

6.2.1 *Passive Locating*

Passive locating is locating buried utilities using the electromagnetic signals that exist in the environment. We group these under two settings:

- Power (P) – these are signals that generally originate from electrical power generation systems. These are around 50/60 Hz and their associated harmonic.
- Radio (R) – these are signals that are generally originated by low frequency radio transmissions. These are generally in the range of 16 kHz to 22 kHz.

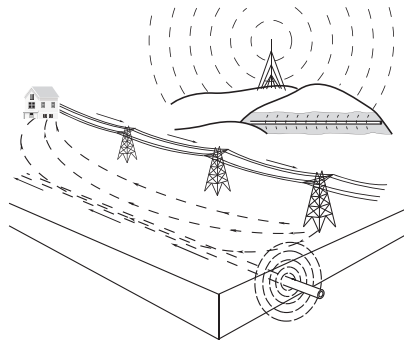

Passive location is used to search an area to see if buried metallic lines are present (known as locating to AVOID). It does not help to identify what buried pipe or cable is present, only to confirm that there is a pipe or cable there. A typical application would be to check an area before installing a fence post.

6.2.2 Active Locating

Active locating is using a transmitter to apply a very precise frequency to a pipe or cable, and then using a receiver turned to find the signal being radiated at that precise frequency. Active location frequencies can be applied by direct connection, clamp or induction.

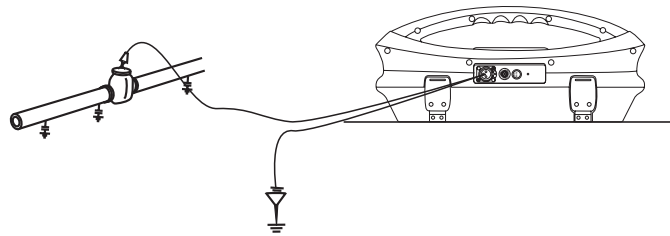

This receiver provides a wide range of frequencies for active location. Some will be the same as the frequencies provided by the Vivax-Metrotech's transmitter, others will be frequencies used in other manufacturers' transmitter.

The choice of frequencies when using induction or the clamp is restricted due to the requirement that these modes be tuned for specific frequencies (or range of frequencies). The full range of frequencies is available in "Direct connection" mode.

For frequencies below 45 kHz, authorities such as the FCC allow higher power output to be used; for frequencies of 45 kHz and above, power output for this type of equipment is restricted to 1 watt. Therefore more power is available when lower frequencies are used.

6.3 Applying the Transmitter's Signal

The transmitter's signal cable is applied in any one of the three ways:

6.3.1 Direct Connection

This is used on pipes or cables that are not live and do NOT carry hazardous voltages. The "Direct connection" mode will be selected automatically when the connection leads are plugged into the transmitter.

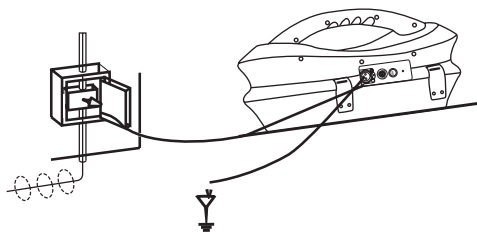



WARNING

Never make a direct connection to live cables carrying hazardous voltages.

Do NOT plug the connection leads into the transmitter before connecting to the buried line and fixing the ground stake.

Take the ground stake and push firmly into the ground and connect it to the black connection lead.

To make the signal travel further along the buried line, ensure to place the ground stake as far away as possible, and at 90 degrees to the line. Where practical avoid having other buried lines between the ground stake and the target line, this will reduce the chances of the transmitter signal coupling to another pipe or cable.

Do NOT connect the black lead to any other metallic items that may have an above or below ground structure, or to any other pipes or cables; connecting to such items would cause signals to radiate from these secondary structures, which in turn will increase the likelihood of an incorrect locate.

Connect the red connection lead to the target line after removing any surface corrosion.

Plug the connection leads into the transmitter switch on and select the desired frequency.



WARNING

BE CAREFUL not to hit other buried lines when inserting the ground stake into the ground. Check using passive location prior to inserting ground stake. Stop if additional resistance is felt during insertion.

6.3.2 *Clamp (Coupler)*

This is used when applying the transmitter signal to cables carrying hazardous voltages, or cables where access to the metallic conductor is not possible, or desirable. The “Clamp” mode is selected automatically when the clamp is plugged into the transmitter.

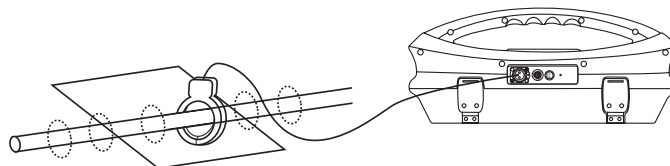

For a clamp to work the current induced by the clamp must flow along the buried line. This means the buried line must have a ground connection at both ends.

Do NOT plug the clamp into the transmitter before applying it to the target line. Open the jaws of the clamp, place around the target line, close the jaws. Be sure that the jaws of the clamp are completely closed. After applying the clamp, plug it into the transmitter, switch on and select the required frequency. Clamps are generally turned to specific frequencies. Your transmitter only allows frequencies that are compatible with the clamp to be selected.

Please note – at the end of the clamp, and in the area close to the clamps hinge the exposed end of the clamp laminations can be seen. Any dirt or corrosion on these ends will reduce the efficiency of the clamp.



WARNING

ALWAYS follow the appropriate safety requirements mandated by safety legislation, safety practice or your company’s safety procedures when applying a clamp (coupler) to a cable.

BEWARE that when placing a clamp around cables carrying high current, the clamp may vibrate, jump or close violently due to inducted current from the target cable.

6.3.3 Induction

This is used when no connection via direct connection leads, or coupler is possible. If no connection leads or clamp are connected to the transmitter, it will automatically select “Induction” mode.

An induction loop is fitted inside the handle of the transmitter. The transmitter must be placed over the target cable with the handle over and in line with the target pipe or cable. The induction loop is tuned to operate at specific frequencies. Only these frequencies can be selected when in “Induction” mode.

Do NOT place the transmitter on a manhole cover, or any other such metallic object, as that object will shield or soak up the signal resulting in little or no signal being induced in the target line.

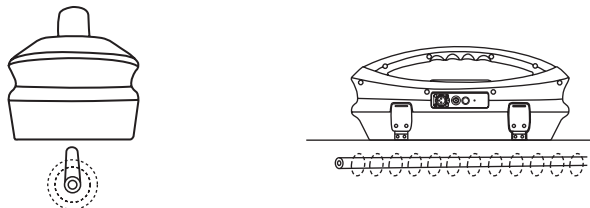

When using the “Induction” mode to apply a signal to a line, ensure that a minimum distance of 50ft (20m) is maintained. This is because the transmitter will transmit signal through the air which will interfere with signals from the cable, resulting incorrect information.

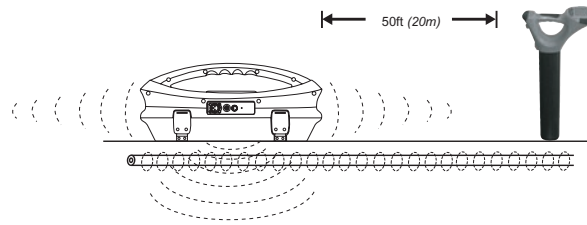

6.3.4 Searching (Sweeping) an Area

In any given area, it is likely that buried pipes and cables are not parallel to each other, frequently they will cross the area being searched at a variety of different angles and depths. As the response of locator antennas is directional, it is important to search the area in the same or similar pattern as below. This orients the antennas in a way that will locate any signals being radiate from the buried line. Once a response is found, then trace and pinpoint the line and mark. Searching an area in this way is generally (but not exclusively) done in the “Peak” mode using passive locating.

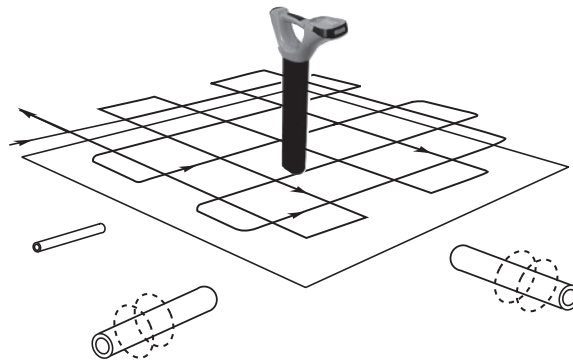

6.3.5 Tracing a Buried Line

Once a buried line is located it is generally necessary, and a good practice, to trace that line for some distance in both directions. Whenever practical it should be traced to a point that provides additional confirmation of what type of service is being located (a telephone pedestal, a manhole cover etc). If tracing a line to which a transmitter signal has been applied, one should trace out from the transmitter connection point. The receiver should be held level to the ground and rotated in a small arc across the anticipated route of the buried line. A clear response should be visible on the display and heard audibly.

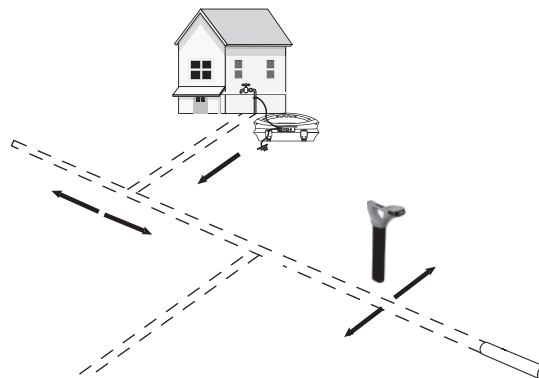

6.3.6 Pinpointing & Confirming the Buried Line

Marking the exact position of the buried line is generally called pinpointing. Pinpoint the line before marking its position. Place the receiver in “Peak” or “Left/Right” mode, pass the blade of the receiver across path of the cable and identify the peak response on the display and/or audibly.

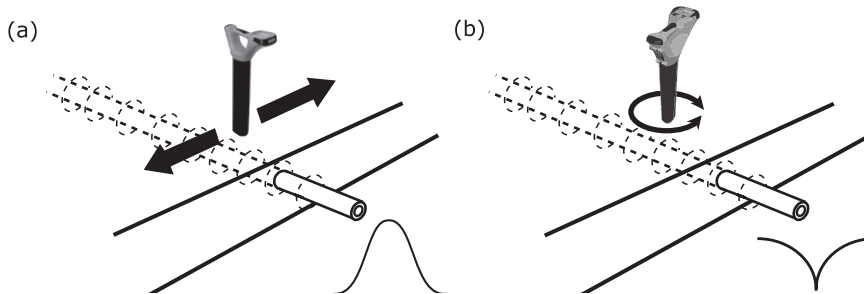

6.3.7 Distorted Fields

When locating always be aware that you are locating the signals radiating from the buried line, and these radiated fields as they are called can be distorted by other lines or electromagnetic buried lines or metallic features like crash barriers or wire mesh fences. The risk of an inaccurate location can be reduced further by the following:

- Check to see if the signal is being distorted by other radiated fields. Locate the cable, first in the “Peak” mode, and then in the null mode. The two locations should indicate that the cable is in the same place. If they do not, the signal field is distorted and the depth measurement may be inaccurate.

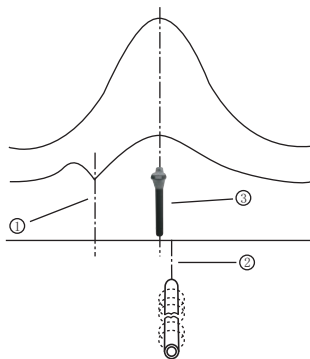

1	Null Position
2	True Position
3	Peak Position

- Measure the depth of the buried line by pressing “i” pushbutton briefly to measure depth and current. The depth should be approximately in line with the “as built” plans available. If no plans are available logic would still help to assess the situation (if you are looking for a CCTV distribution cable and the depth indicated is 5ft (1.5m) it is probably not your cable). Current will be displayed at the same time as the depth.
- A depth reading on congested areas or close to bends or tee’s maybe inaccurate due to distorted fields.

6.3.8 Measuring Depth and Current

Pinpoint the cable as described in “Pinpointing cable”, with the receiver in line with and directly above the buried line – measure the depth (d) by pressing “i” pushbutton briefly. Current will be displayed at the same time as the depth.

Be careful when locating in congested areas or close to bends or tee’s, they may be inaccurate due to distorted fields.

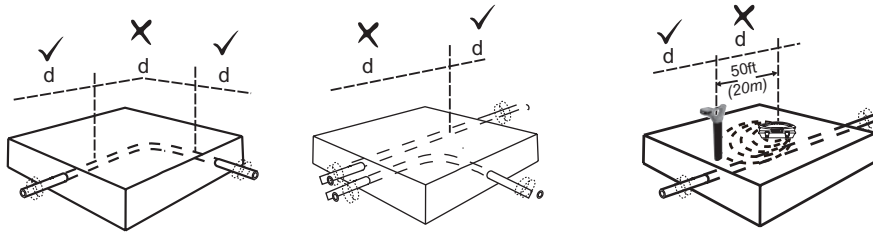

An alternate method of verifying depth (D) is triangulation which must be done Broad peak mode. There are two methods of triangulation, 50% and 70% rules. On some models there is an option that instructs the user in taking triangulation measurements.

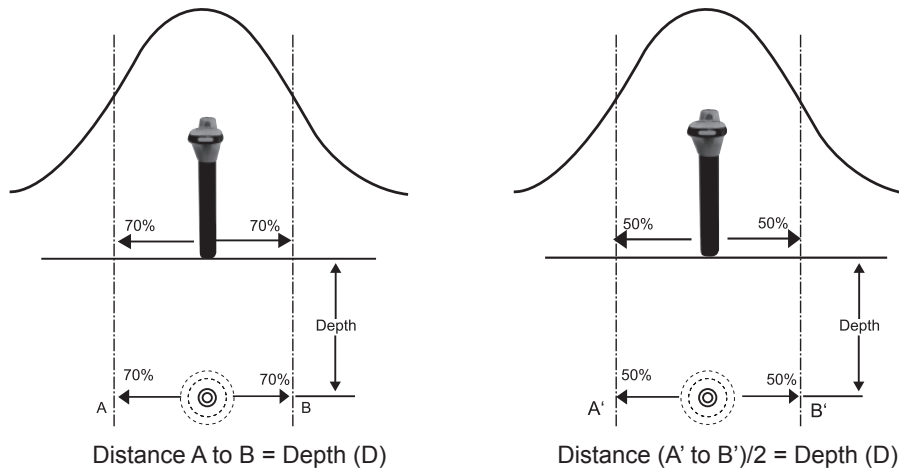

Semi Automatic Triangulation Mode

On some models a "triangulation mode" is available that assist in taking these types of measurements.

To use the Triangulation mode the function must first be activated in the User Menu.

To use the function first locate the cable or pipe in the usual way.

Press the “i” pushbutton and a depth will be indicated. To confirm with triangulation, press the “i” pushbutton again.

The following screen should be shown.

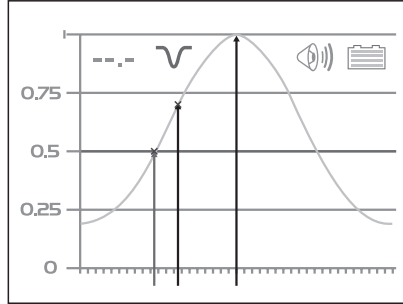

Now slowly move the locator to the side until the line on the graph reaches the 50% line. (or 70% if the 70% rule is used). At this point an audible beep will confirm this position is reached. Mark the ground at this point and then slowly return to the peak position. Continue past this position until the 50% mark is reached on the other side. Mark this position.

Now measure the distance between these two points. Divide the distance by two. The result will indicate the depth of the target line.

If the 70% rule is used, do not divide by two, the depth is equal to the distance between the points.

Measure the current. This is displayed when you briefly press the “i” pushbutton to measure depth. The signal from the transmitter will attenuate with distance. The further you are away from the transmitter the less signal will radiate from the buried line. By locating at several points along the buried line you will identify an approximate rate of signal loss (beware that where a pipe or cable divides the signal will reduce more rapidly). If the signal at the point you are pinpointing is different from the trend would suggest – between that, it may not be the buried line you expect.



WARNING

NEVER mechanically dig over the path of a buried pipe or cable. ALWAYS dig carefully.

6.3.9 Cable Tracing using Signal Select or Signal Direction Signals

Energizing cables or pipe with a known signal enables them to be traced with a certain degree of confidence. However, it is quite common for signals to bleed off onto other lines. This can result in confusion especially in congested sites or where services run in parallel for some distance.

Signal Select and Signal Direction are well tried and tested methods of identifying which line the transmitter is connected to. The systems considerably increase the confidence of identification but it should always be kept in mind that there is no method that can give 100% reliability.

Both Signal Select and Signal Direction rely on the fact that signals that have bled from the target line travel back towards the transmitter and very often use adjacent lines as easy paths. Hence

the return signals tend to be flowing in the opposite direction than that of the connected line. As we are using signals that are alternating in nature it can also be considered that the return signals are in the opposite phase than the applied signal.

Signal select and Signal Direction can only be applied to a target line using the Direct Connection method or using a low frequency signal clamp. SiS and SD cannot be applied using the Induction method.

Signal Select does not require phase setting to the transmitter but is generally better for short distance applications.

Signal Direction (SD) is used for both short and long distance applications but does need referencing to the transmitter.

SignalSelect

Apply the transmitter SiS tone using the Loc-10TxSIS. Not all frequencies are available with Signal select. Ones that are available are identified with “SiS” Ensure the receiver and transmitter are set to the same frequency.

The direction of the signal in the targeted line is determined by analyzing the sign of the demodulated Signal Select signal. When the receiver is positioned over a signal that carries an inverted field (i.e., one in which the phase is -180° from the expected, the Guidance Compass points down, as shown below for a line that is bonded to the target line and carries return current.

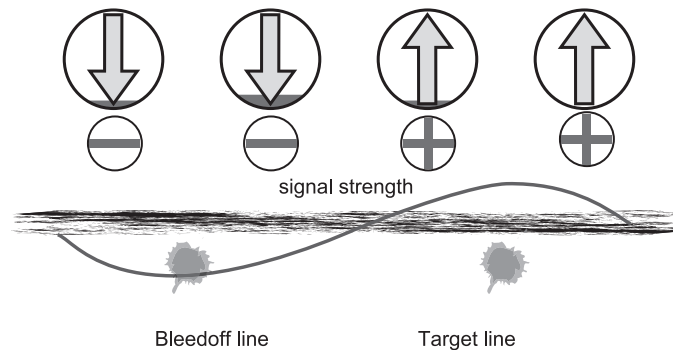

Signal Select Sample Scenario

An example of how the Distortion Alert feature acts as a warning about situations that (using traditional methods) appear to be quite ordinary can be seen below. In this case, there is significant bleedover from the target line to a shallower line, with the current running in the same direction forward in both lines. Since the bleedover line is shallower, its effect diminishes as the receiver is positioned farther to the right or left. Thus the red filling is at a lower level in the Guidance Compass in these areas. The measured distortion approaches a peak about in the same place as the signal strength peak, indicating the presence of another conductor.

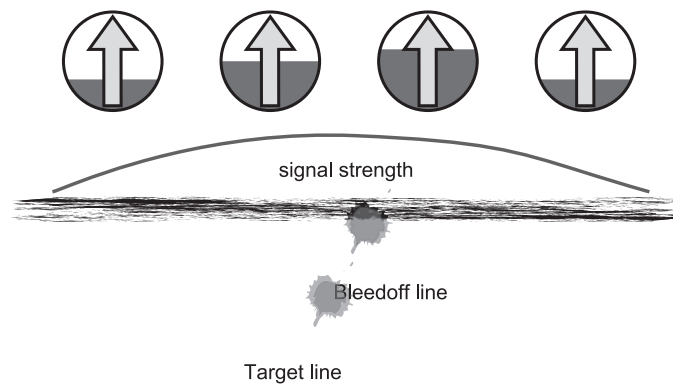

Distortion Alert Sample Scenario

In this particular case, the centerline estimate is not significantly biased, though the depth estimate is less accurate.



NOTE

If the **Signal Select** modulation is used, the problem may occur that the **current flow direction displayed on the receiver is opposite to the actual flow direction in the target line. Thus the following test must be carried out prior to every measurement using Signal Select:**

Choose a location where the target line can be clearly identified and check the displayed current flow direction. If the shown direction is wrong, turn the Signal Select pincer or interchange the connection lines. As a result, the displayed and the actual current flow direction should match each other. Now the measurement can be started.

Distortion Alert

Distortion creates phase anomalies in the signal, which can be detected at the receiver and compared to a phase reference imparted at the transmitter. This reference is set by Signal Select modulation for every active frequency imparted at the transmitter. The transmitter must be in direct (conductive) connection mode, and Signal Select modulation must be switched on for each frequency (this is the default). Even if multiple simultaneous outputs are on, any or all can be selected to carry the modulated output. For each transmitter output that is Signal Select modulated, there is an independent control loop to ensure that the phase reference is zero. The level of distortion in the field is proportional to the level of the red background in the Guidance Compass.

It is not necessarily true that when the Guidance Compass background is predominantly red that a poor locate results. The Distortion Alert feature is just that, an alert that a non-ideal magnetic field is detected. In some cases the conductor that carries the bleedover current may lay directly on top (in the same duct) of the target conductor. In this case, the predominant current that is detectable at the surface is from the bleedover line, but the actual centerline estimate is correct.

6.3.10 Signal Direction Precision Identification

Some models in the vLoc series of locators contain a feature called “SIGNAL DIRECTION”. This feature is used to verify if the line being located is the line to which the transmitter has been connected.

When a transmitter is connected to a target line the signal travels along it and finds the easiest way to travel back, usually via the ground and ground stake. However, very often the signal will travel back along adjacent cables or pipes as these can offer an easier route.

As a result there can be multiple signals radiating from cables and pipes in the area making it difficult to identify the target line. These return signals are typically traveling in the opposite direction than the applied signal. The Signal Direction feature identifies which direction the signal is flowing and hence the target line.

To use the signal direction system:

- Connect the transmitter to the target line using a direct connection only.

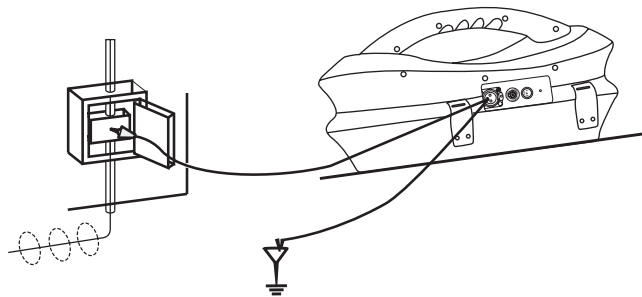

- Turn the transmitter and receiver on and set both to:
 - SD-USA – if in North America or any territory where the power system is 60Hz.
 - SD-EUR – if in Europe or any territory where the power system is 50Hz.
- The receiver may, or may not be flashing the “SD” icon “A flashing icon indicates that the unit needs to be synchronized with the transmitter.” Even if the icon is not flashing it is always good practice to synchronize the system at the beginning of a survey to ensure reliable results and to maximize the distance to the next synchronization point.
- To synchronize the receiver to the transmitter at the beginning of a survey, pinpoint the line very close to the transmitter – be sure that it is the correct line. Then, standing facing away from where the transmitter is attached and press the “i” pushbutton. The unit will now display the information screen showing the depth of line, signal current and a hand with the “SD” icon positioned over the return pushbutton. Pressing the return pushbutton will synchronize the system and return the unit to the locate screen. The Line Direction Indicator will now be pointing forward and the SD icon will not be flashing indicating the receiver is locked onto the signal. The system is now synchronized.

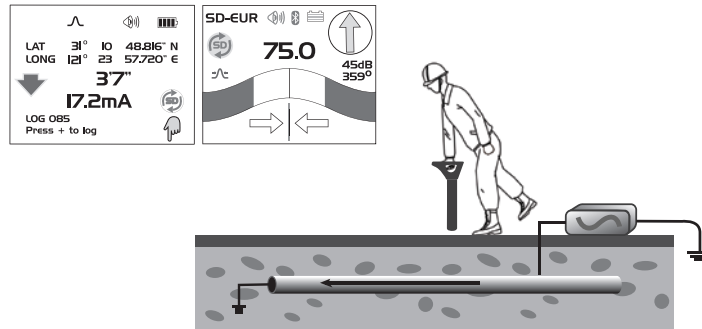

- Proceed to locate, trace, pinpoint as required ensuring at all times the line direction indicator is pointing forward.
- If at any time the line direction indicator is pointing backwards – you are not locating the correct line, you are locating a line which is carrying the return signal.

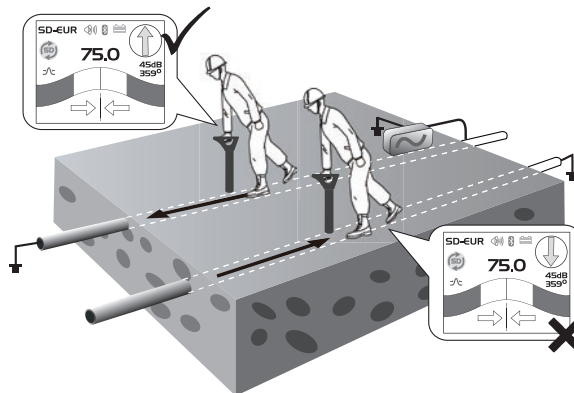

- At some point you may find that the SD icon and start flashing – this is indicating that synchronization with the transmitter has deteriorated and a reset is required.

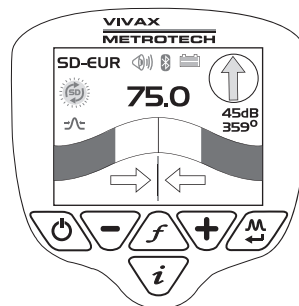

- Re-trace your line back to a point where a solid signal direction is obtained. Precisely pinpoint the line and stand with your back to the direction of the transmitter as you did when you initiated the original sync and press the “i” pushbutton then the enter pushbutton to re-sync with the transmitter signal.
- Continue to locate, pinpoint and trace.



NOTE

If several lines are commonly bonded the Signal Direction will carry through to the other lines. This is useful for locating multiple line installations. However be aware that if a non target line is commonly bonded to the target line that line will also appear as being “in Sync” with the target line. When performing a reset, take care to ensure that you have not strayed from the target line.

6.4 Using the Accessories

6.4.1 Using the LPC Separation Filter



The LPC separation filter (LPC) is used to safely inject a trace tone to a live cable via a domestic mains socket, so that the cable can be traced from the premises to the connection in the street. It is suitable for connecting to voltages between 100V AC and 250V AC.

Method:

Plug the LPC into the output socket of the transmitter. Identify a suitable main socket. If a switch is fitted to the socket, switch off. Plug in the LPC to the mains socket and then switch back on. Set the LPC rotary switch to match the two indicator lights. Set the transmitter to the frequency to be located.(8 kHz or 32 kHz are good frequencies for this application). Set the output to mid range.

6.4.2 Using the A-frame in Fault Finding



The A-frame accessory is used to detect ground faults on pipes and cables. In the case of pipes, the faults consist of coating defects. In the case of cables, faults are usually caused by insulation damage allowing the metallic sheath (or internal conductor) to become in contact with the ground.

To detect a damaged section, the line should be isolated and have all ground bonding removed. This will ensure that the ground fault is not masked by deliberate bonding to ground. The A-frame cannot distinguish between these two situations.

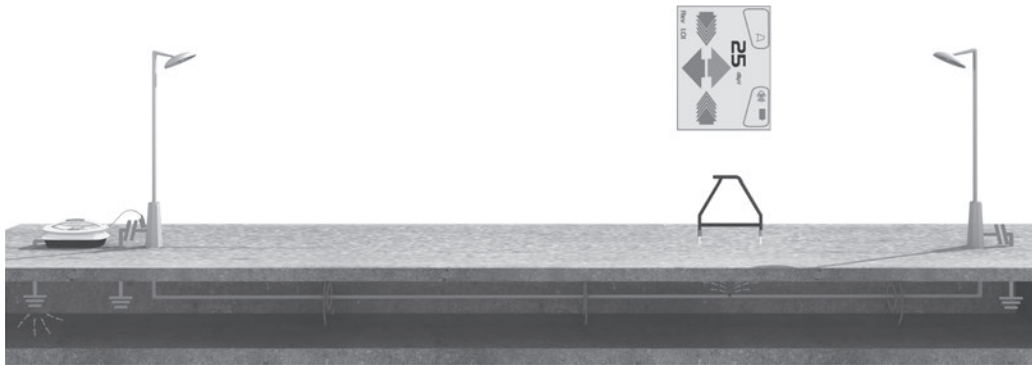

After isolating the line, use the vLoc-5000 transmitter resistance measuring function, or a dedicated resistance measuring device to confirm that there is a fault to ground. The A-frame will typically detect faults up to 2 mega ohm and above (depending on the distance from transmitter, soil conditions etc).

Connect the transmitter to the target line using the red lead. A groundstake needs to be pushed into the ground and the black cable clipped to it. Try to place the groundstake as far as possible from the line to be evaluated. This ensures return currents do NOT distort the results. Switch on the transmitter and select either FF low or FF high. Use FF high if the line to be surveyed is long or the fault resistance is high.

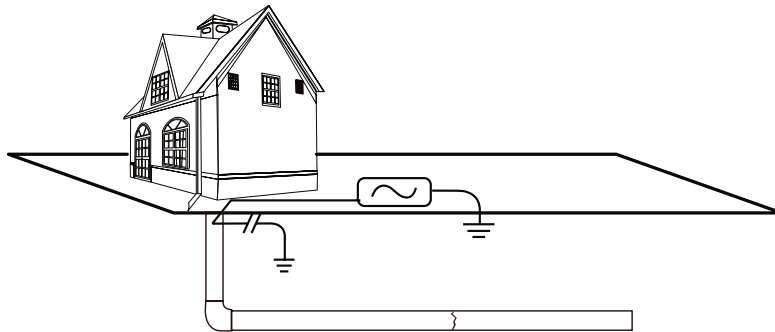

Plug in the A-frame to the receiver accessory socket. When the receiver is switched on, it will automatically default to the A-frame screen.

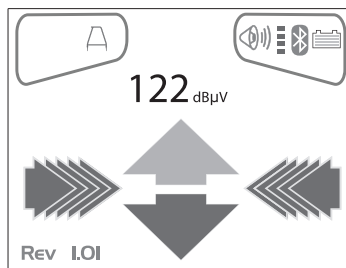
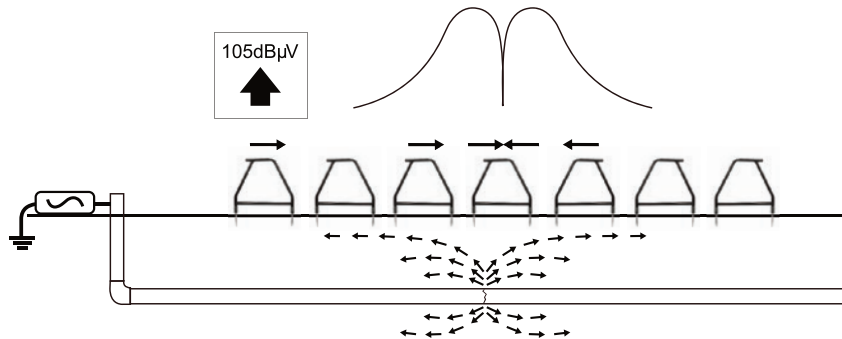

Image for reference only and may differ from actual image

Remove the plastic spike covers from the A-frame. Walk along the route of the line placing the spikes of the A-frame in the ground (with the green leg pointing away from the transmitter connection point) every two or three paces. If starting near the transmitter, the Arrow on the display will point away from

the ground point. As the distance from the transmitter increases, the dBuV reading will reduce and eventually the arrow will fluctuate or disappear all together. This is because the fault location is further along the line. If the left/right arrows are activated, use them to ensure the A-frame is positioned over the line and continue placing the A-frame in the ground every two or three paces. If the left/right arrows are not activated use the “M” pushbutton to enter the locate screen allowing the user to confirm the position of the target line. Press the “M” pushbutton again to re enter the A-frame mode.

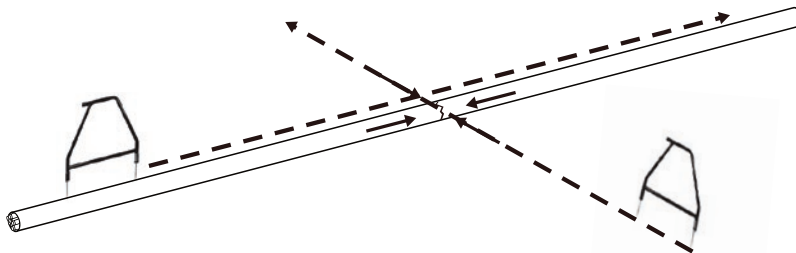

Eventually the A-frame will detect the fault signal and the “Fault Find” arrow will point forwards. Continue moving forwards, it may be worth reducing the distance between measurements points as the fault is neared. The dBuV reading will increase as the fault is neared. Maximum reading will be just before and just after the fault. When over the fault, the dBuV reading will drop and the arrow will flip backwards indicating that the position of the fault has been passed. Carefully place the A-frame before and after the fault to pinpoint the position. Repeating this across the line direction will pinpoint the fault laterally. The fault will be at the point where the lateral fault is identified.

**WARNING**

Always disconnect or isolate cables before making connections to conductors. Never attach the transmitter to live cables unless authorised. Use the appropriate accessories.

**TIP**

If it is suspected that there is just one fault. Insert the A-frame approximately one meter from the earth stake. Note the dBuV, this is approximately the maximum dBuV reading that will be measured over the fault.

6.4.3 Using the SIS Remote Antenna USB



The SIS remote antenna is a mini antenna that connects to the vLoc-5000 receiver for line tracing or cable identification. Equipped with Signal Select, the SIS remote antenna becomes a powerful tool that easily identifies a particular cable on a cable tray or where cables are bunched together by providing a visible positive or negative icon (+ and -) and an illuminated top or bottom bezel on the receiver's operational interface.

Theory of Operation:

The SIS remote antenna is a receiver antenna extension utilizing a directional coil to locate cables. Because the SIS remote antenna is directional, the position of the SIS remote antenna during operation determines how the received signal is evaluated.

Locating Method:

1. The SIS remote antenna is positioned with the "This side to cable".



With the Signal Select feature active on the transmitter and receiver, these positions will also trigger a plus (+) icon and an illuminated top portion of the bezel on the Receiver to help identify the direction of the signal on the targeted cable. The blue fill inside the circle indicates signal distortion.

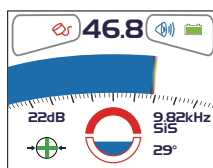

SIS remote antenna. No depth or current measurements are available using this method of operation.

6.4.4 Signal Select™ Clamp



Signal Select Clamp Mode

Plugging the signal select clamp supplied by Vivax-Metrotech into the output socket will place the transmitter in Signal Select Clamp mode. An icon confirming this is displayed on the display. The icon flashes when the transmitter is transmitting. When using the clamp no ground connection is needed.

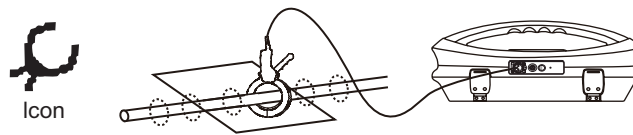

A negative (-) icon appears on the operational interface if the operator finds a parallel line or a return current instead of the desired line. Tracing along a line will provide a constant indication of the same polarity.

Operational Mode

The transmitter can be coupled to the cable inductively with a signal clamp. Since the signal generated from the clamp is directional, clamp orientation is important and must be connected in such a way that imprinted arrow on the clamp points to the cable end.

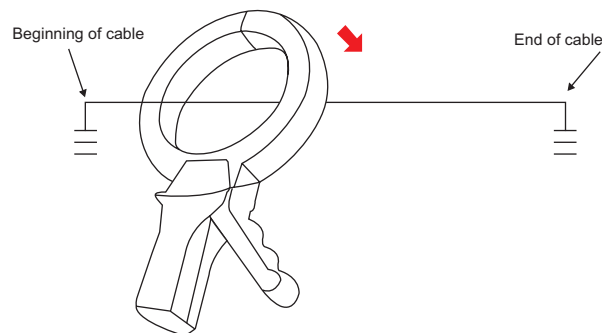

Used in conjunction with the vLoc-5000 receiver, the Signal Select feature becomes a powerful tool in aiding accurate cable identification. At the receiver, a positive (+) icon appears on the operational interface if the operator correctly identifies and traces the line.

A negative (-) icon appears on the operational interface if the operator finds a parallel line or a return current instead of the desired line. Tracing along a line will provide a constant indication of the same polarity.

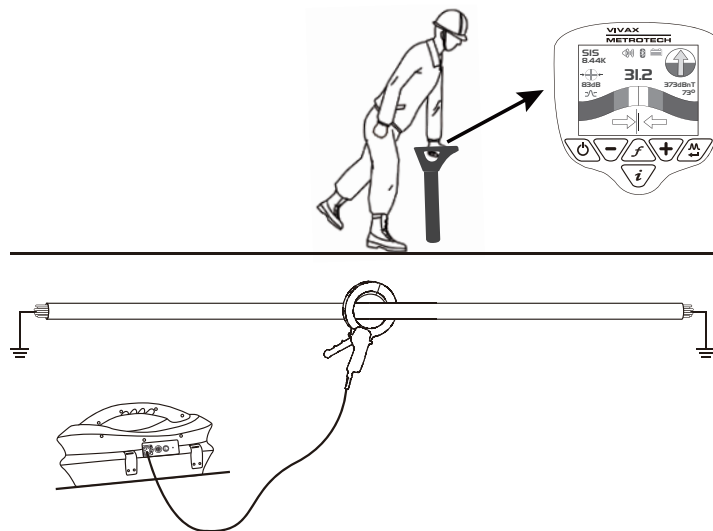

Accessories & Options

7.1 A-frame (Optional)



The A-frame accessory is used to detect ground faults on pipes and cables. In the case of pipes, the faults consist of coating defects. In the case of cables, faults are usually caused by insulation damage allowing the metallic sheath (or internal conductor) to become in contact with the ground.

7.2 Remote Antenna (Optional)



The remote antenna can be used to help identify a particular cable on a cable tray or where cables are bunched together.

7.3 Loc-10Tx Vehicle Power Lead (Optional)

12V DC, 30ft (10m) lead to power the transmitter from a vehicle.

Note, this is NOT a charge lead.



If it is intended to apply the transmitter to a target line at high output levels and long periods, it may be useful to power the transmitter using the 12V DC vehicle power lead. To power the transmitter from the 12V DC vehicle power lead, connect the lead to the 12V DC input positioned on the side of the transmitter. Plug the cigarette lighter plug into the vehicle cigarette lighter socket (be sure that the socket is live. Some vehicles only activate the cigarette lighter when the vehicle is running).

It is not necessary to disconnect or remove the standard batteries as the unit will automatically select the external 12V DC supply.

7.4 Loc-10Tx Outdoor Power Supply (Optional)



12V DC, 30ft (10m) lead to power (NOT charge lead) the transmitter from the mains supply.

Note, this is NOT a charge lead.

7.5 LPC Separation Filter (Optional)



The LPC separation filter (LPC) is used to safely inject a trace tone to a live cable via a domestic mains socket, so that the cable can be traced from the premises to the connection in the street. It is suitable for connecting to voltages between 100V AC and 250V AC.

7.6 Receiver Vehicle Charging Lead(Optional)



12ft (4m) long lead to charge the receiver's battery (Lithium-ion) while on the move.

It is preferable to connect the charger to a cigarette lighter socket that is permanently live. However, do NOT leave connected to the receiver for excessively long periods.

7.7 Sonde (Optional)



D18-33-SR44 Sonde

- 0.75in (18mm) x 3.1in (80mm) long, 33 kHz, range 12ft (4m).
- 2 x button cell batteries.

D38-33-AA Sonde

- 1.5in (38mm) x 4.1in (105mm) long, 33 kHz, range 15ft (5m).
- 1 x AA battery.

D64-33-LR61 Sonde

- 2.5in (64mm) x 7.3in (186mm) long, 33 kHz, range 24ft (8m).
- 1 x LR61 battery.

D23F-512-AA / D23F-640-AA Sonde

- 1in (23mm) x 18in (456mm) long, range 20ft (7m).
- "Flexible (3 section) Sonde with optional 512Hz or 640Hz for use in cast iron pipes".
- 1 x AA battery.

7.8 Clamp (Optional)



- VX2/50, VX4/100, VX5/125, VX18/450F
- Dia. 2in (50mm), Dia. 5in (125mm), Dia. 4in (100mm), 18in flexible (Circumference 450mm)

An accessory used to apply the transmitter signal to an insulated line, removing the need to connect the transmitter signal directly to a conductor or cable sheath.

7.9 Lithium-ion Rechargeable Battery Pack (Standard)



The Lithium-ion rechargeable battery pack is supplied as standard. Use the battery charger listed below to charge the battery pack. Charging is done with the battery inside the receiver.

7.10 Receiver Battery Charger (Standard)



The receiver Lithium-ion battery charger is supplied as a standard item. It is powered from the mains supply (100-250V AC)

7.11 USB Cable(Standard)



The USB cable is used to connect the receiver to a host computer so that software updates can be implemented and also for the transfer of data logs from the unit to a computer.

7.12 Alkaline Battery Holder(Standard)

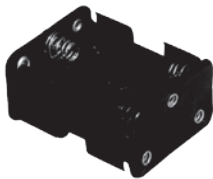

This battery pack is supplies as standard and is used in the event the rechargeable battery pack has fully discharged. It can be considered as a backup battery pack. It requires 6 x AA alkaline batteries.

7.13 Ground Stake(Standard)



Used to make an independent connection to the ground so as to complete the circuit when the transmitter is connected to a line using the direct connection method.

7.14 Direct Connection Lead(Standard)



Used to connect the transmitter to a line using the direct connection method.

7.15 Ground Spool(Optional)



Used to extend the ground connection to a suitable grounding position.

7.16 Banana Plugs Adapter (Optional)



Adapts the direct connection crocodile clip to banana plug allowing the direct connection leads to be connected to a banana socket.

7.17 Loc-5Tx/10Tx Charger



Mains charger (100-250V AC input) used to charge 5 Watt or 10 Watt rechargeable battery packs. Supplied as standard with rechargeable battery option.

7.18 Loc-10Tx Rechargeable Battery Tray



NiMH rechargeable battery pack. Only use the charger supplied.

7.19 Loc-10Tx Alkaline Battery Tray



Requires 12 x Alkaline D cells.

Glossary

Active Locate	A locate where a transmitter is used to apply a signal to a buried pipe or cable, the position of which is then located by a receiver tuned to the same frequency.
Active Signal	A signal applied by the locator transmitter to a buried line. Typical this is a very precise frequency.
Attenuation	The reduction of an electromagnetic signal from a pipe or cable.
Clamp (or Coupler)	An accessory used to apply the transmitter signal to an insulated line, removing the need to connect the transmitter signal directly to a conductor or cable sheath.
Compass	Line direction indicator (although visually like a compass, this is the only relation to a compass.)
Coupling	The act of signals transferring to lines to which they were not originally applied. Coupling can be “direct” where the target line has an electrical connection to another line, or “induced” where the signal radiates from the target line to another line or lines.
Display	The information visually available on the dot matrix display.
Line	A generic term for any buried pipe or cable.
Null	A minimum response to a buried line.
Passive Locate	A locate where the receiver searches for a wide range of signals that radiate from buried pipes or cables. These signals come from a variety of sources in the environment and couple to the buried (& overhead) lines. Typical examples 50/60Hz and LF/VLF radio.
Passive signals	A wide range of signals that radiate from buried pipes or cables. These signals come from a variety of sources in the environment and couple to the buried (& overhead) lines. Typical examples 50/60Hz and LF/VLF radio.

8 Glossary

Peak	A maximum response to a buried line.
Pinpoint	Using a receiver to identify the exact position of a buried line.
Response	The indication that the receiver gives which is caused by the signals it is receiving. This can be visual, audio or both. Typically it is displayed on the locators dot matrix display and audibly from a loudspeaker in the receiver housing.
Search (sweep)	This describes the act of looking for a buried line within a given area.
Sonde	A small transmitting coil which may be built into a product such as a sewer camera or packaged as a small self contained battery powered transmitter. A receiver tuned to the same frequency can locate the position of the Sonde and hence whatever it is attached to or in. Frequently used for locating sewer cameras, and the non metallic pipes.
Target Line	The buried pipe or cable to be located.
Trace	Using a locator to following the path of a buried line.

Illustrations used in the preparation of this manual will inevitably show some resemblance to similar illustrations from other Manufacturers-some manufacturers have given permission for the use of their graphics (Vivax-Metrotech & Seba) is given credit for these use. This statement is intended to attribute such credit.

Disclaimer: Product and accessory specification and availability information is subject to change without prior notice.

